

AVR 310 Audio/Video Receiver

OWNER'S MANUAL

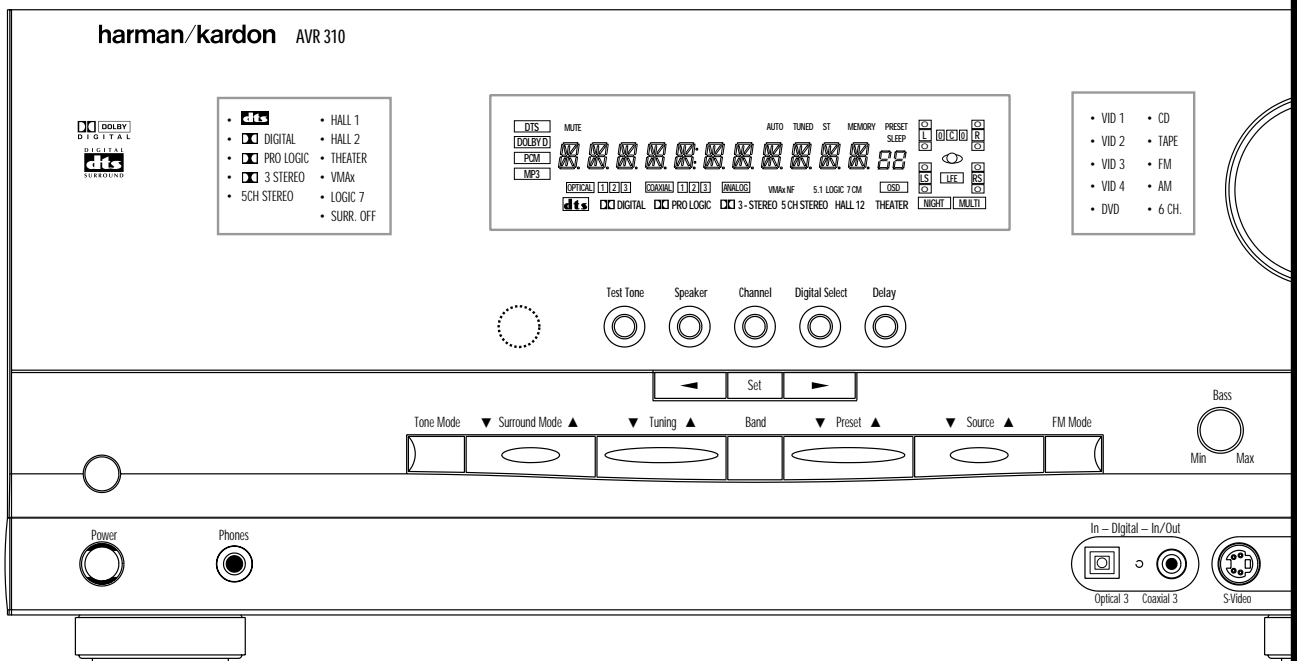

harman/kardon®

Power for the Digital Revolution.™

AVR 310 Audio/Video Receiver

3	Introduction
4	Safety Information
4	Unpacking
5	Front Panel Controls
7	Front Panel Information Display
9	Rear Panel Connections
11	Main Remote Control Functions
14	Zone II Remote Control Functions
15	Installation and Connections
17	System Configuration
19	Input Setup
19	Surround Setup
20	Delay Settings
21	Speaker Setup
22	Output Level Adjustment
23	Manual Output Level Adjustment
25	Operation
25	Basic Operation
25	Source Selection
26	Surround Mode Chart
27	Surround Mode Selection
27	Digital Audio Playback
27	Selecting a Digital Source
29	Tuner Operation
30	Tape Recording
30	Front Panel Input/Output Connections
30	Output Level Trim Adjustment
31	6-Channel Direct Input
32	Advanced Features
32	Display Brightness
32	Turn-On Volume Level
32	Semi-OSD Settings
34	Multiroom Operation
35	Programming the Remote
35	Direct Code Entry
35	Auto Search Method
35	Code Readout
36	Learning Codes
36	Erasing Learned Codes
36	Macro Programming
37	Programmed Device Functions
38	Volume Punch-Through
38	Channel Control Punch-Through
39	Reassigning Device Control Selectors
40	Function List
42	Setup Code Tables
52	Troubleshooting Guide
52	Processor Reset
53	Technical Specifications

Typographical Conventions

In order to help you use this manual with the remote control, front panel controls and rear panel connections, certain conventions have been used.

EXAMPLE – (bold type) indicates a specific remote control or front panel button, or rear panel connection jack

EXAMPLE – (OCR type) indicates a message that is visible on the front panel information display

EXAMPLE – (outlined type) indicates a lit indicator in the front panel information display

1 – (number in a square) indicates a specific front panel control

1 – (number in a circle) indicates a rear panel connection

1 – (number in an oval) indicates a button or indicator on the remote

A – (letter in a square) indicates an indicator in the front panel display

A – (letter in an oval) indicates a button on the Zone II remote

Introduction

Thank you for choosing Harman Kardon!

With the purchase of a Harman Kardon AVR 310 you are about to begin many years of listening enjoyment. The AVR 310 has been custom-designed to provide all the excitement and detail of movie soundtracks and every nuance of musical selections. With onboard Dolby* Digital and DTS® decoding, the AVR 310 delivers six discrete channels of audio that take advantage of the digital soundtracks from the latest DVD and LD releases and Digital Television broadcasts.

While complex digital systems are hard at work within the AVR 310 to make all of this happen, hookup and operation are simple. Color-keyed connections, a programmable remote control, and on-screen menus make the AVR 310 easy to use. To obtain the maximum enjoyment from your new receiver, we urge you to take a few minutes to read through this manual. This will ensure that connections to speakers, source playback units and other external devices are made properly. In addition, a few minutes spent learning the functions of the various controls will enable you to take advantage of all the power the AVR 310 is able to deliver.

If you have any questions about this product, its installation or its operation, please contact your retailer or custom installer. They are your best local sources of information.

Description and Features

The AVR 310 is among the most versatile and multi-featured A/V receivers available, incorporating a wide range of listening options. In addition to Dolby Digital and DTS decoding for digital sources, a broad choice of analog surround modes are available for use with sources such as CD, VCR, TV broadcasts and the AVR 310's own FM/AM tuner. Along with Dolby Pro Logic*, Dolby 3 Stereo and custom Hall and Theater modes, only Harman Kardon receivers offer Logic 7® to create a wider, more enveloping field environment and more defined flyovers and pans. Another Harman Kardon exclusive is VMaX®, which uses proprietary process-

ing to create an open, spacious sound field even when only two front speakers are available. Finally, the AVR 310 is among the very few A/V receivers that offer decoding of MP3 data, so that you may listen to the latest music selections directly from compatible computers or playback devices with the power and fidelity you expect from Harman Kardon.

In addition to providing a wide range of listening options, the AVR 310 is easy to configure so that it provides the best results with your speakers and specific listening-room environment. On-screen menus make it simple to enter settings for speakers, inputs and delay times, while our exclusive EzSet™ remote measures a system's sound levels and automatically calibrates them for perfectly balanced soundfield presentation.

For the ultimate in flexibility, the AVR 310 features connections for four video devices, all with both composite and S-Video inputs. Two additional audio inputs are available, and a total of six digital inputs make the AVR 310 capable of handling all the latest digital audio sources. Coax and optical digital outputs are available for direct connection to digital recorders, and the front-panel coaxial jack may be switched to an output for use with portable recorders – a Harman Kardon exclusive. Two video recording outputs, preamp outputs for use with external power amplifiers, and a six channel input make the AVR 310 virtually future-proof, with everything needed to accommodate tomorrow's new formats right on board.

The AVR 310's flexibility and power extend beyond your main home-theater or listening room. The AVR 310 includes a sophisticated multi-zone control system that allows you to select one source for use in the main room and a different one in a second room. Complete control over volume is possible with a separate infrared control link. To make it easy to operate the AVR 310 from a remote room, a separate "Zone II" remote is included.

The AVR 310's powerful amplifier uses traditional Harman Kardon high-current design technologies to meet the wide dynamic range of any program selection.

Harman Kardon invented the high-fidelity receiver more than forty-seven years ago. With state-of-the-art circuitry and time-honored circuit designs, the AVR 310 is one of the finest receivers ever offered by Harman Kardon.

- **Onboard Dolby Digital and DTS Decoding Using Crystal® Chip Technology**
- **Harman Kardon's Exclusive Logic 7 and VMaX Modes**
- **MP3 Decoding for Use with Computers and Digital Audio Players**
- **|||||EzSet™ Remote Automatically Sets Output Levels for Optimum Performance**
- **Front-Panel Digital Inputs and Coax Digital Output Capability for Easy Connection to Portable Digital Devices and the Latest Video Game Consoles**
- **Multiple Digital Inputs and Outputs**
- **On-Screen Menu and Display System**
- **6-Channel Direct Input and Preamp Outputs for Easy Expansion and Use with Future Audio Formats**
- **Complete Multi-Zone System with Separate "Zone II" Remote Included**

CAUTION

RISK OF ELECTRIC SHOCK DO NOT OPEN

CAUTION: To prevent electric shock, do not use this (polarized) plug with an extension cord, receptacle or other outlet unless the blades can be fully inserted to prevent blade exposure.



The lightning flash with arrowhead symbol, within an equilateral triangle, is intended to alert the user to the presence of uninsulated "dangerous voltage" within the product's enclosure that may be of sufficient magnitude to constitute a risk of electric shock to persons.



The exclamation point within an equilateral triangle is intended to alert the user to the presence of important operating and maintenance (servicing) instructions in the literature accompanying the appliance.

Safety Information

Important Safety Information

Verify Line Voltage Before Use

Your AVR 310 has been designed for use with 120-volt AC current. Connection to a line voltage other than that for which it is intended can create a safety and fire hazard and may damage the unit.

If you have any questions about the voltage requirements for your specific model, or about the line voltage in your area, contact your selling dealer before plugging the unit into a wall outlet.

Do Not Use Extension Cords

To avoid safety hazards, use only the power cord attached to your unit. We do not recommend that extension cords be used with this product. As with all electrical devices, do not run power cords under rugs or carpets or place heavy objects on them. Damaged power cords should be replaced immediately by an authorized service depot with a cord meeting factory specifications.

Handle the AC Power Cord Gently

When disconnecting the power cord from an AC outlet, always pull the plug, never pull the cord. If you do not intend to use the unit for any considerable length of time, disconnect the plug from the AC outlet.

Do Not Open the Cabinet

There are no user-serviceable components inside this product. Opening the cabinet may present a shock hazard, and any modification to the product will void your guarantee. If water or any metal object such as a paper clip, wire or a staple accidentally falls inside the unit, disconnect it from the AC power source immediately, and consult an authorized service station.

CATV or Antenna Grounding

If an outside antenna or cable system is connected to this product, be certain that it is grounded so as to provide some protection against voltage surges and static charges. Section 810 of the National Electrical Code, ANSI/NFPA No. 70-1984, provides information with respect to proper grounding of the mast and supporting structure, grounding of the lead-in wire to an antenna discharge unit, size of grounding conductors, location of antenna discharge unit, connection to grounding electrodes and requirements of the grounding electrode.

NOTE TO CATV SYSTEM INSTALLER: This reminder is provided to call the CATV (Cable

TV) system installer's attention to article 820-40 of the NEC that provides guidelines for proper grounding and, in particular, specifies that the cable ground shall be connected to the grounding system of the building, as close to the point of cable entry as possible.

Installation Location

- To assure proper operation and to avoid the potential for safety hazards, place the unit on a firm and level surface. When placing the unit on a shelf, be certain that the shelf and any mounting hardware can support the weight of the product.
- Make certain that proper space is provided both above and below the unit for ventilation. If this product will be installed in a cabinet or other enclosed area, make certain that there is sufficient air movement within the cabinet. Under some circumstances a fan may be required.
- Do not place the unit directly on a carpeted surface.
- Avoid installation in extremely hot or cold locations, or an area that is exposed to direct sunlight or heating equipment.
- Avoid moist or humid locations.
- Do not obstruct the ventilation slots on the top of the unit, or place objects directly over them.

Cleaning

When the unit gets dirty, wipe it with a clean, soft, dry cloth. If necessary, wipe it with a soft cloth dampened with mild soapy water, then a fresh cloth with clean water. Wipe dry immediately with a dry cloth. NEVER use benzene, aerosol cleaners, thinner, alcohol or any other volatile cleaning agent. Do not use abrasive cleaners, as they may damage the finish of metal parts. Avoid spraying insecticide near the unit.

Moving the Unit

Before moving the unit, be certain to disconnect any interconnection cords with other components, and make certain that you disconnect the unit from the AC outlet.

Important Information for the User

This equipment has been tested and found to comply with the limits for a Class-B digital device, pursuant to Part 15 of the FCC Rules. The limits are designed to provide reasonable protection against harmful interference in a residential installation. This equipment generates, uses and can radiate radio-frequency energy and, if not installed and used in accordance

with the instructions, may cause harmful interference to radio communication. However, there is no guarantee that harmful interference will not occur in a particular installation. If this equipment does cause harmful interference to radio or television reception, which can be determined by turning the equipment off and on, the user is encouraged to try to correct the interference by one or more of the following measures:

- Reorient or relocate the receiving antenna.
- Increase the separation between the equipment and receiver.
- Connect the equipment into an outlet on a circuit different from that to which the receiver is connected.
- Consult the dealer or an experienced radio/TV technician for help.

This device complies with Part 15 of the FCC Rules. Operation is subject to the following two conditions: (1) this device may not cause harmful interference, and (2) this device must accept interference received, including interference that may cause undesired operation.

NOTE: Changes or modifications may cause this unit to fail to comply with Part 15 of the FCC Rules and may void the user's authority to operate the equipment.

Unpacking

The carton and shipping materials used to protect your new receiver during shipment were specially designed to cushion it from shock and vibration. We suggest that you save the carton and packing materials for use in shipping if you move, or should the unit ever need repair.

To minimize the size of the carton in storage, you may wish to flatten it. This is done by carefully slitting the tape seams on the bottom and collapsing the carton. Other cardboard inserts may be stored in the same manner. Packing materials that cannot be collapsed should be saved along with the carton in a plastic bag.

If you do not wish to save the packaging materials, please note that the carton and other sections of the shipping protection are recyclable. Please respect the environment and discard those materials at a local recycling center.

At this time you should remove the protective plastic film from the front-panel lens. Leaving the film in place may affect the performance of your remote control.

Front Panel Controls

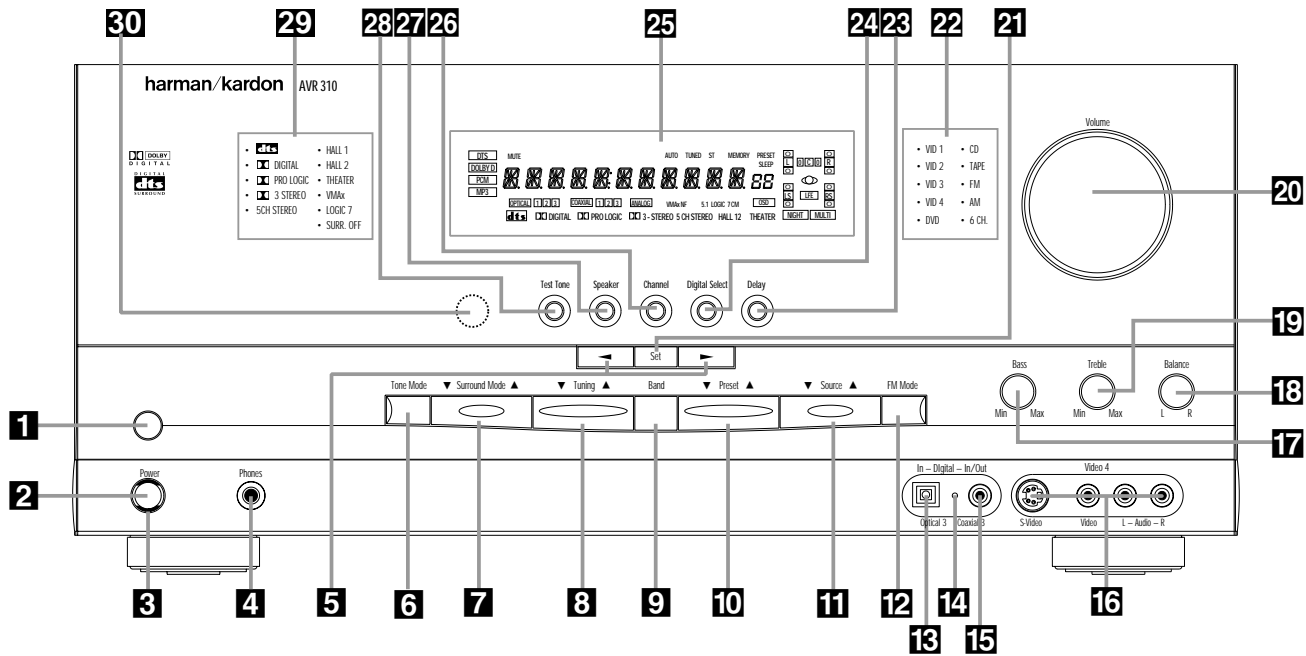

- 1** Main Power Switch
- 2** System Power Control
- 3** Power Indicator
- 4** Headphone Jack
- 5** Selector Buttons
- 6** Tone Mode
- 7** Surround Mode Selector
- 8** Tuning Selector
- 9** Tuner Band Selector
- 10** Preset Stations Selector

- 11** Input Source Selector
- 12** FM Mode Selector
- 13** Digital Optical 3 Input
- 14** Digital Coax 3 Status Indicator
- 15** Digital Coax 3 Jack
- 16** Video 4 Input Jacks
- 17** Bass Control
- 18** Balance Control
- 19** Treble Control
- 20** Volume Control

- 21** Set Button
- 22** Input Indicators
- 23** Delay
- 24** Digital Input Selector
- 25** Main Information Display
- 26** Channel Select Button
- 27** Speaker Select Button
- 28** Test Tone Selector
- 29** Surround Mode Indicators
- 30** Remote Sensor Window

1 Main Power Switch: Press this button to apply power to the AVR 310. When the switch is pressed in, the unit is placed in a Standby mode, as indicated by the amber LED **3** surrounding the **System Power Control 2**. This button **MUST** be pressed in to operate the unit. To turn the unit off and prevent the use of the remote control, this switch should be pressed until it pops out from the front panel so that the word "OFF" may be read at the top of the switch.

NOTE: This switch is normally left in the "ON" position.

2 System Power Control: When the **Main Power Switch 1** is "ON," press this button to turn on the AVR 310; press it again to turn

the unit off. Note that the **Power Indicator** surrounding the switch **3** will turn green when the unit is on.

3 Power Indicator: This LED will be illuminated in amber when the unit is in the Standby mode to signal that the unit is ready to be turned on. When the unit is in operation, the indicator will turn green.

4 Headphone Jack: This jack may be used to listen to the AVR 310's output through a pair of headphones. Be certain that the headphones have a standard 1/4" stereo phone plug. Note that the main room speakers will automatically be turned off when the headphone jack is in use.

5 Selector Buttons: When you are establishing the AVR 310's configuration settings, use these buttons to select from the choices available, as shown in the **Main Information Display 25**.

6 Tone Mode: Pressing this button enables or disables the Bass and Treble tone controls. When the button is pressed so that the words TONE IN appear in the **Main Information Display 25**, the settings of the **Bass 17** and **Treble 19** controls may be used to adjust the output signals. When the button is pressed so that the words TONE OUT appear in the **Main Information Display 25**, the output signal will be "flat," without any bass or treble alteration, no matter how the actual **Bass** and **Treble** controls **17/19** are adjusted.

Front Panel Controls

7 Surround Mode Selector: Press this button to change the surround mode by scrolling through the list of available modes. Note that depending on the type of input, some modes are not always available. (See page 26 for more information about surround modes.)

8 Tuning Selector: Press the left side of the button to tune lower frequency stations and the right side of the button to tune higher frequency stations. When a station with a strong signal is reached, the **TUNED** indicator **W** will be illuminated in the **Main Information Display 25**.

To tune manually, tap the button lightly and note that the tuner will step up one frequency increment per button press. When the button is held for a few seconds you will note that the unit will quickly search the frequency band. Release it once the fast tuning starts; the tuner will automatically scan for the next station with an acceptable signal and then stop.

9 Tuner Band Selector: Pressing this button will automatically switch the AVR 310 to the Tuner mode. Pressing it again will switch between the AM and FM frequency bands. (See page 29 for more information on the tuner.)

10 Preset Stations Selector: Press this button to scroll up or down through the list or stations that have been entered into the preset memory. (See page 30 for more information on tuner programming.)

11 Input Source Selector: Press this button to change the input by scrolling up or down through the list of input sources.

12 FM Mode Selector: Press this button to select Auto or Manual tuning. When the button is pressed so that the **AUTO** Indicator **X** lights, the tuner will search for the next station with an acceptable signal when the **Tuning Selector 8 21 E** is pressed. When the button is pressed so that the **AUTO** Indicator **X** is not lit, each press of the **Tuning Selector 8 21 E** will increase the frequency. (See page 29 for more information on using the tuner.)

13 Digital Optical 3 Input: Connect the optical digital output of an audio or video product to this jack. When the Input is not in use, be certain to keep the plastic cap installed to avoid dust contamination that might degrade future performance.

14 Digital Coax 3 Status Indicator: This LED indicator will normally light green to show that the Digital Coax 3 jack is operating as an input. When the jack has been configured as an output the indicator will turn red to show that the jack may be used for recording. (See page 19 for more information on configuring the Digital Coax 3 jack.)

15 Digital Coax 3 Jack: This jack is normally used for connection to the output of portable audio devices, video game consoles or other products that have a coax digital jack. It may also be configured as an output jack, to feed a digital signal to a CD-R, MiniDisc or other digital recording device. (See page 30 for information on configuring the Digital Coax 3 Jack to an output.)

16 Video 4 Input Jacks: These audio/video jacks may be used for temporary connection to video games or portable audio/video products such as camcorders and portable audio players.

17 Bass Control: Turn this control to modify the low frequency output of the left/right channels by as much as ± 10 dB. Set this control to a suitable position for your taste or room acoustics.

18 Balance Control: Turn this control to change the relative volume for the front left/right channels.

NOTE: For proper operation of the surround modes this control should be at the midpoint or "12 o'clock" position.

19 Treble Control: Turn this control to modify the high frequency output of the left/right channels by as much as ± 10 dB. Set this control to a suitable position for your taste or room acoustics.

20 Volume Control: Turn this knob clockwise to increase the volume, counterclockwise to decrease the volume. If the AVR 310 is muted, adjusting volume control will automatically release the unit from the silenced condition.

21 Set Button: When making choices during the setup and configuration process, press this button to enter the desired setting as shown in the **Main Information Display 25** into the AVR 310's memory. The set button may also be used to change the display brightness. (See page 32.)

22 Input Indicators: A green LED will light in front of the input that is currently being used as the source for the AVR 310.

23 Delay: Press this button to begin the sequence of steps required to enter delay time settings. (See page 20 for more information on delay times.)

24 Digital Input Selector: When playing a source that has a digital output, press this button to select between the **Optical 13 28** and **Coaxial 15 29 Digital** inputs. (See pages 27–29 for more information on digital audio.)

25 Main Information Display: This display delivers messages and status indications to help you operate the receiver. (See pages 7–8 for a complete explanation of the Information Display.)

26 Channel Select Button: Press this button to begin the process of trimming the channel output levels using an external audio source. (For more information on output level trim adjustment, see page 30.)

27 Speaker Select Button: Press this button to begin the process of selecting the speaker positions that are used in your listening room. (See page 21 for more information on setup and configuration.)

28 Test Tone Selector: Press this button to begin the process of adjusting the channel output levels using the internal test tone as a reference. (For more information on output level adjustment, see page 22.)

29 Surround Mode Indicators: A green LED will light in front of the surround mode that is currently in use.

30 Remote Sensor Window: The sensor behind this window receives infrared signals from the remote control. Aim the remote at this area and do not block or cover it unless an external remote sensor is installed.

Front Panel Information Display

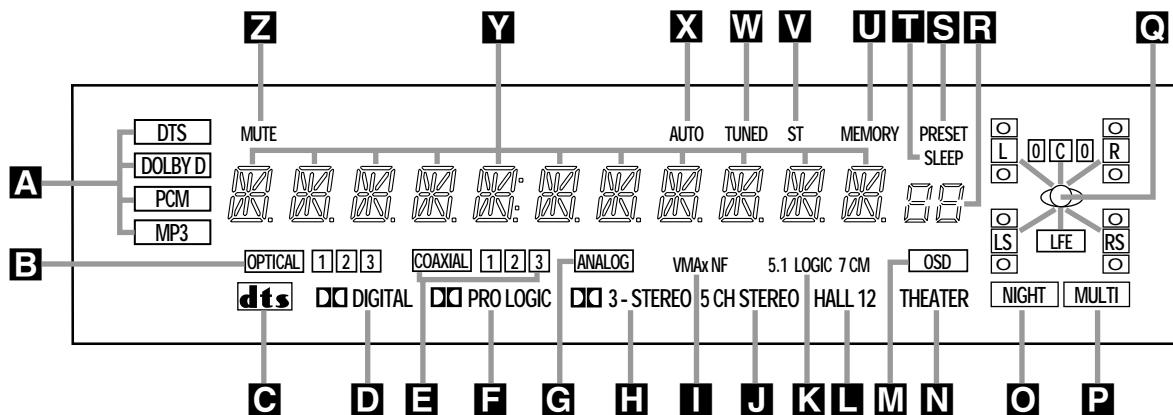

- | | | |
|------------------------------------|---|-----------------------------------|
| A Bitstream Indicators | J 5 Channel Stereo Indicator | S Preset Indicator |
| B Optical Source Indicators | K Logic 7 Mode Indicators | T Sleep Indicator |
| C DTS Mode Indicator | L Hall Mode Indicator | U Memory Indicator |
| D Dolby Digital Indicator | M OSD Indicator | V Stereo Indicator |
| E Coaxial Source Indicators | N Theater Mode Indicator | W Tuned Indicator |
| F Dolby Pro Logic Indicator | O Night Mode Indicator | X Auto Indicator |
| G Analog Input Indicator | P Multiroom Indicator | Y Main Information Display |
| H Dolby 3 Stereo Indicator | Q Speaker/Channel Input Indicators | Z Mute Indicator |
| I VMaX Mode Indicator | | |

A Bitstream Indicators: When the input is a digital source, one of these indicators will light to display the specific type of data signal in use.

B Optical Source Indicators: These indicators light to show when an Optical Digital Input has been selected.

C DTS Mode Indicator: This indicator lights when a DTS-encoded source is playing.

D Dolby Digital Indicator: This indicator lights when a Dolby Digital source is being played.

E Coaxial Source Indicators: These indicators light to show when a Coaxial Digital Input has been selected.

F Dolby Pro Logic Indicator: This indicator lights when the Dolby ProLogic mode has been selected.

NOTE: It is possible to see the Dolby Pro Logic indicator lit simultaneously with the Dolby Digital indicator, even though the Dolby Digital surround mode has been selected. This is due to the specifications for Dolby Digital processing, which require that the Dolby Pro Logic mode apply any time a 2-channel Dolby signal is detected. If you desire 5.1-channel audio, check the audio settings in the menus for both your DVD player and your DVD disc to make sure that a 5.1-channel Dolby Digital soundtrack has been selected.

G Analog Input Indicator: This indicator lights when an analog input source has been selected.

H Dolby 3 Stereo Indicator: This indicator lights when the Dolby 3 Stereo Mode has been selected.

I VMaX Mode Indicator: This indicator lights when the VMaX mode is in use. **VMaX F** appears when the Far Field VMaX mode is selected; **VMaX N** appears when the Near Field VMaX mode is selected. (See page 26 for a description of the VMaX Modes.)

J 5 Channel Stereo Indicator: This indicator lights when the 5 Channel Stereo mode has been selected.

K Logic 7 Mode Indicators: These indicators light when the Logic 7 mode is in use. **LOGIC 7C** appears for the Cinema version of Logic 7, **LOGIC 7M** appears for the Music version of Logic 7. (See page 26 for a description of the Logic 7 Modes.)

L Hall Mode Indicators: These indicators light when one of the Hall modes has been selected.

M OSD Indicator: When the OSD system is in use, this indicator lights to remind you that the other indicators in this display do not function when the On Screen Display is being used.

N Theater Mode Indicator: This indicator lights to show that the Theater mode is in use.

O Night Mode Indicator: This indicator lights when the AVR 310 is in the Night mode, which preserves the dynamic range of digital program material at low volume levels.

P Multiroom Indicator: This indicator lights when the multiroom system is active. Note that it will remain lit when the multiroom system is in use even though the main room system is in the Standby mode and all other indicators are dark. (See page 34 for more information on the Multiroom system.)

Q Speaker/Channel Input Indicators: These indicators are multipurpose, indicating either the speaker type selected for each channel or the incoming data-signal configuration. The left, center, right, right surround and left surround speaker indicators are composed of three boxes, while the subwoofer is a single box. The center box lights when a "Small" speaker is selected, and the two outer boxes light when "Large" speakers are selected. When none of the boxes are lit for the center, surround or subwoofer channels, no speaker has been selected for one of those positions. (See page 21 for more information on configuring speakers.) The letters inside each of the center boxes display active input channels. For standard analog inputs, only the L and R will light, indicating a stereo input. When a digital source is playing, the indicators

Front Panel Information Display

will light to display the channels being received at the digital input. When the letters flash, the digital input has been interrupted. (See page 28 for more information on the Channel Indicators.)

R Preset Number/Sleep Timer: When the tuner is in use, these numbers indicate the specific preset memory location in use. (See page 29 for more information on preset stations.) When the Sleep function is in use, these numbers show how many minutes remain before the unit goes into the Standby mode.

S Preset Indicator: This indicator lights when the tuner is in use to show that the **Preset Number/Sleep Timer R** is showing the station's preset memory number. (See page 30 for more information on tuner presets.)

T Sleep Indicator: This indicator lights when the Sleep function is in use. The numbers in the Preset Number/Sleep Timer Indicators will show the minutes remaining before the AVR 310 goes into the Standby mode. (See page 25 for more information on the Sleep function.)

U Memory Indicator: This indicator flashes when entering presets and other information into the tuner's memory.

V Stereo Indicator: This indicator lights when an FM station is being tuned in stereo.

W Tuned Indicator: This indicator lights when a station is being received with sufficient signal strength to provide acceptable listening quality.

X Auto Indicator: This indicator lights when the tuner's Auto mode is in use.

Y Main Information Display: This display shows messages relating to the status, input source, surround mode, tuner, volume level or

other aspects of the AVR 310's operation.

Z Mute Indicator: This indicator lights to remind you that the AVR 310's output has been silenced by pressing the **Mute** button  **M**. Press the Mute button again to return to the previously selected output level.

Rear Panel Connections

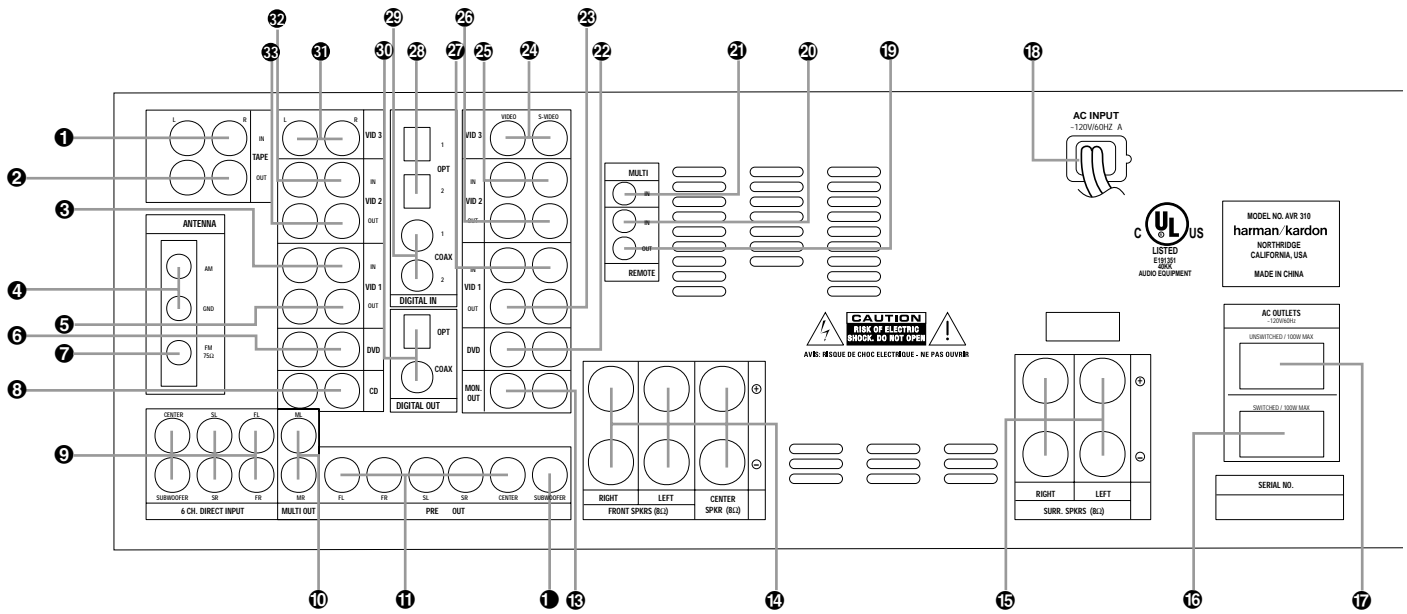

- 1 Tape Inputs
- 2 Tape Outputs
- 3 Video 1 Audio Inputs
- 4 AM Antenna
- 5 Video 1 Audio Outputs
- 6 DVD Audio Inputs
- 7 FM Antenna
- 8 CD Inputs
- 9 6-Channel Direct Inputs
- 10 Multiroom Outputs
- 11 Preamp Outputs
- 12 Subwoofer Output
- 13 Video Monitor Outputs
- 14 Front Speaker Outputs

- 15 Surround Speaker Outputs
- 16 Switched AC Accessory Outlet
- 17 Unswitched AC Accessory Outlet
- 18 AC Power Cord
- 19 Remote IR Output
- 20 Remote IR Input
- 21 Multiroom IR Input
- 22 DVD Video Inputs
- 23 Video 1 Video Outputs
- 24 Video 3 Video Inputs
- 25 Video 2 Video Inputs
- 26 Video 2 Video Outputs
- 27 Video 1 Video Inputs
- 28 Optical Digital Inputs

- 29 Coaxial Digital Inputs
- 30 Digital Audio Outputs
- 31 Video 3 Audio Inputs
- 32 Video 2 Audio Inputs
- 33 Video 2 Audio Outputs

Rear Panel Connections

1 Tape Inputs: Connect these jacks to the **PLAY/OUT** jacks of an audio recorder.

2 Tape Outputs: Connect these jacks to the **RECORD/INPUT** jacks of an audio recorder.

3 Video 1 Audio Inputs: Connect these jacks to the **PLAY/OUT** audio jacks on a VCR or other video source.

4 AM Antenna: Connect the AM loop antenna supplied with the receiver to these terminals. If an external AM antenna is used, make connections to the **AM** and **GND** terminals in accordance with the instructions supplied with the antenna.

5 Video 1 Audio Outputs: Connect these jacks to the **RECORD/INPUT** audio jacks on a VCR.

6 DVD Audio Inputs: Connect these jacks to the analog audio jacks on a DVD or other video source.

7 FM Antenna: Connect the supplied indoor or an optional external FM antenna to this terminal.

8 CD Inputs: Connect these jacks to the output of a compact disc player or CD changer.

9 6-Channel Direct Inputs: If an external digital audio decoder is used, connect the outputs of that decoder to these jacks.

10 Multiroom Outputs: Connect these jacks to an optional audio power amplifier to listen to the source selected by the multiroom system in a remote room.

11 Preamp Outputs: These jacks may be connected to an external power amplifier.

1 Subwoofer Output: Connect this jack to the line-level input of a powered subwoofer. If an external subwoofer amplifier is used, connect this jack to the subwoofer amplifier input.

13 Video Monitor Outputs: Connect this jack to the composite or S-Video input of a TV monitor or video projector to view the on-screen menus and the output of any standard video source selected by the receiver's video switcher.

14 Front Speaker Outputs: Connect these outputs to the matching + or – terminals on your front speakers. When making speaker connections, always make certain to maintain

correct polarity by connecting the red (+) terminals on the AVR 310 to the red (+) terminals on the speaker and the black (–) terminals on the AVR 310 to the black (–) terminals on the speakers. (See page 15 for more information on speaker polarity.)

15 Surround Speaker Outputs: Connect these outputs to the matching + or – terminals on your left and right surround speakers. When making speaker connections always make certain to maintain correct polarity by connecting the red (+) terminals on the AVR 310 to the red (+) terminals on the speakers and the black (–) terminals on the AVR 310 to the black (–) terminals on the speakers. See page 15 for more information on speaker polarity.

16 Switched AC Accessory Outlet: This outlet may be used to power any device you wish to have turned on when the AVR 310 is turned on with the **System Power Control** switch **2**.

17 Unswitched AC Accessory Outlet: This outlet may be used to power any AC device. The power will remain on at this outlet regardless of whether the AVR 310 is on or off.

Note: The total power consumption of all devices connected to the accessory outlets should not exceed 100 watts.

18 AC Power Cord: Connect the AC plug to an unswitched AC wall output.

19 Remote IR Output: This connection permits the IR sensor in the receiver to serve other remote controlled devices. Connect this jack to the "IR IN" jack on Harman Kardon (or other compatible) equipment.

20 Remote IR Input: If the AVR 310's front-panel IR sensor is blocked due to cabinet doors or other obstructions, an external IR sensor may be used. Connect the output of the sensor to this jack.

21 Multiroom IR Input: Connect the output of an IR sensor in a remote room to this jack to operate the AVR 310's multiroom control system.

22 DVD Video Inputs: Connect these jacks to the composite or S-Video output jacks on a DVD or other video source.

23 Video 1 Video Outputs: Connect these jacks to the **RECORD/INPUT** composite or S-Video jack on a VCR.

24 Video 3 Video Inputs: Connect these jacks to the **PLAY/OUT** composite or S-Video jacks on a VCR or other video source.

25 Video 2 Video Inputs: Connect these jacks to the **PLAY/OUT** composite or S-Video jacks on a VCR or other video source.

26 Video 2 Video Outputs: Connect these jacks to the **RECORD/INPUT** composite or S-Video jacks on a VCR.

27 Video 1 Video Inputs: Connect these jacks to the **PLAY/OUT** composite or S-Video jacks on a VCR or other video source.

28 Optical Digital Inputs: Connect the optical digital output from a DVD player, HDTV receiver, LD player or CD player to these jacks. The signal may be either a Dolby Digital signal, a DTS signal or a standard PCM digital source.

29 Coaxial Digital Inputs: Connect the coaxial digital output from a DVD player, HDTV receiver, LD player or CD player to these jacks. The signal may be either a Dolby Digital signal, DTS signal or a standard PCM digital source. Do not connect the RF digital output of an LD player to these jacks.

30 Digital Audio Outputs: Connect these jacks to the matching digital input connector on a digital recorder such as a CD-R or MiniDisc recorder.

31 Video 3 Audio Inputs: Connect these jacks to the **PLAY/OUT** audio jacks on a VCR or other video source.

32 Video 2 Audio Inputs: Connect these jacks to the **PLAY/OUT** audio jacks on a VCR or other video source.

33 Video 2 Audio Outputs: Connect these jacks to the **RECORD/INPUT** audio jacks on a VCR or other video source.

Main Remote Control Functions

- ❶ Power On Button
- ❷ IR Transmitter Window
- ❸ Program/SPL Indicator
- ❹ Power Off Button
- ❺ Input Selectors
- ❻ AVR Selector
- ❼ AM/FM Tuner Select
- ❽ Learn Button
- ❾ Test Button
- ❿ Sleep Button
- ⓫ Surround Mode Selector
- ⓬ Night Mode
- ⓭ Channel Select Button
- ⓮ ▲/▼ Buttons
- ⓯ ◀ Button
- ⓰ Set Button
- ⓱ Digital Select
- ⓲ Numeric Keys
- ⓳ Tuner Mode
- ⓴ Direct Button
- ⓵ Tuning Up/Down
- ⓶ OSD Button
- ⓷ Macro Buttons
- ⓸ Transport Controls
- ⓹ Skip Up/Down Buttons
- ⓺ Disc Skip Buttons
- ⓻ Preset Up/Down
- ⓼ Clear Button
- ⓽ Memory Button
- ⓿ Delay/Prev. Ch.
- ⓾ ▶ Button
- ⓿ Speaker Select
- ⓿ Multiroom
- ⓿ Volume Up/Down
- ⓿ TV/Video Selector
- ⓿ SPL Indicator Select
- ⓿ 6-Channel Direct Input
- ⓿ Mute
- ⓿ EzSet Sensor Microphone

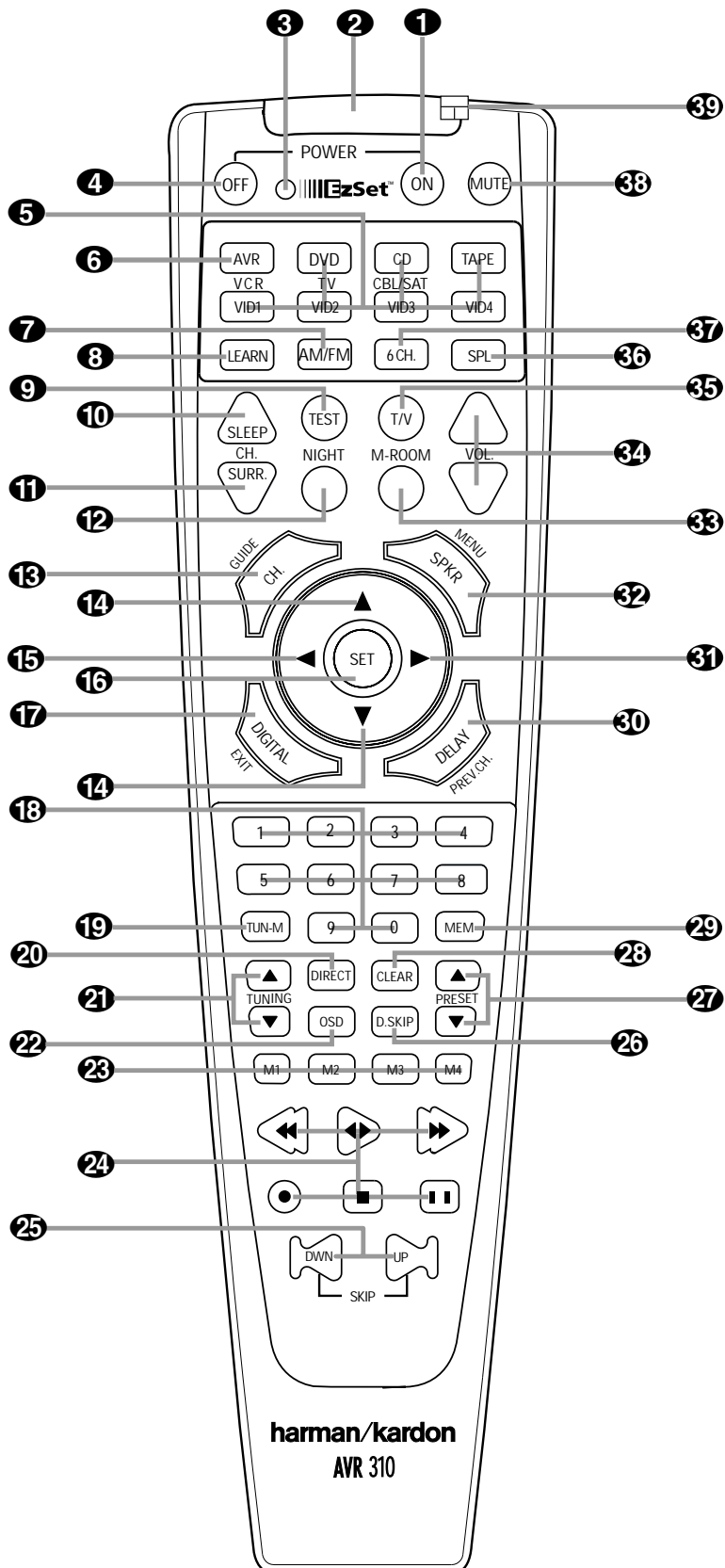

NOTE: The function names shown here are each button's feature when used with the AVR 310. Most buttons have additional functions when used with other devices. See pages 40–41 for a list of these functions.

Main Remote Control Functions

IMPORTANT NOTE: The AVR 310's remote may be programmed to control up to eight devices, including the AVR 310. Before using the remote, it is important to remember to press the **Input Selector** button **5** that corresponds to the unit you wish to operate. In addition, the AVR 310's remote is shipped from the factory to operate the AVR 310 and most Harman Kardon CD or DVD players and cassette decks. The remote is also capable of operating a wide variety of other products using the control codes that are part of the remote. Before using the remote with other products, follow the instructions on pages 35–39 to program the proper codes for the products in your system.

It is also important to remember that many of the buttons on the remote take on different functions, depending on the product selected using the Device Control Selectors. The descriptions shown here primarily detail the functions of the remote when it is used to operate the AVR 310. (See page 37 for information about alternate functions for the remote's buttons.)

1 Power On Button: Press this button to turn on the power to a device selected by pressing one of the **Input Selectors 5**.

2 IR Transmitter Window: Point this window towards the AVR 310 when pressing buttons on the remote to make certain that infrared commands are properly received.

3 Program/SPL Indicator: This three-color indicator is used to guide you through the process of programming the remote or learning commands from a remote into the AVR 310's remote code memory and it is also used as a level indicator when using the remote's EzSet capabilities. (See page 22 for more information on setting output levels, and see page 35 for information on programming the remote.)

4 Power Off Button: Press this button to place the AVR 310 or a selected device in the Standby mode. Note that this will turn off the main room functions, but if the Multiroom system is activated, it will continue to function.

5 Input Selectors: Pressing one of these buttons will perform three actions at the same time. First, if the AVR 310 is not turned on, this will power up the unit. Next, it will select the source shown on the button as the input to the AVR 310. Finally, it will change the remote control so that it controls the device selected. After pressing one of these buttons you must press the **AVR Selector** button **6** again to operate the AVR 310's functions with the remote.

6 AVR Selector: Pressing this button will switch the remote so that it will operate the AVR 310's functions. If the AVR 310 is in the Standby mode, it will also turn the AVR 310 on.

7 AM/FM Tuner Select: Press this button to select the AVR 310's tuner as the listening choice. Pressing this button when the tuner is already in use will select between the AM and FM bands.

8 Learn Button: Press this button to begin the process of "learning" the codes from another product's remote into the AVR 310's remote. (See page 36 for more information on using the remote's learning function.)

9 Test Button: Press this button to begin the sequence used to calibrate the AVR 310's output levels. (See page 22 for more information on calibrating the AVR 310.)

10 Sleep Button: Press this button to place the unit in the Sleep mode. After the time shown in the display, the AVR 310 will automatically go into the Standby mode. Each press of the button changes the time until turn-off in the following order:

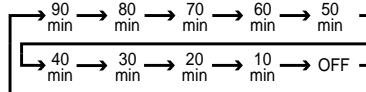

Note that this button is also used to change channels on your TV when the TV is selected.

When the AVR 310 remote is being programmed with the codes to operate another device, this button is also used in the "Auto Search" process. (See page 35 for more information on programming the remote.)

11 Surround Mode Selector: Press this button to begin the process of changing the surround mode. After the button has been pressed, use the **▲/▼** buttons **14** to select the desired surround mode. (See page 27 for more information.) Note that this button is also used to tune channels when the TV is selected using the device **Input Selector 5**. When the AVR 310 remote is being programmed with the codes of another device, this button is also used in the "Auto Search" process. (See page 35 for more information on programming the remote.)

12 Night Mode: Press this button to activate the Night mode. This mode is available in specially encoded digital sources, and it preserves

dialog (center channel) intelligibility at low volume levels.

13 Channel Select Button: This button is used to start the process of setting the AVR 310's output levels to an external source. Once this button is pressed, use the **▲/▼** buttons **14** to select the channel being adjusted, then press the **Set** button **16**, followed by the **▲/▼** buttons again, to change the level setting. (See page 30 for more information.)

14 ▲/▼ Buttons: These are multi-purpose buttons. They will be used most frequently to select a surround mode. To change the surround mode, first press the **Surround Mode ▼** selector

11. Next press these buttons to scroll up or down through the list of surround modes that appear in the **Main Information Display 25**. These buttons are also used to increase or decrease output levels when configuring the unit with either the internal test tone or an external source. They are also used to enter delay time settings after the **Delay** button **30** has been pressed.

15 ◀ Button: This button is used to change the menu selection or setting during some of the setup procedures for the AVR 310.

16 Set Button: This button is used to enter settings into the AVR 310's memory. It is also used in the setup procedures for delay time, speaker configuration and channel output level adjustment.

17 Digital Select: Press this button to assign one of the digital inputs **13 15** to a source. (See page 27 for more information on using digital inputs.)

18 Numeric Keys: These buttons serve as a ten-button numeric keypad to enter tuner preset positions. They are also used to select channel numbers when **TV** has been selected on the remote, or to select track numbers on a CD, DVD or LD player, depending on how the remote has been programmed.

19 Tuner Mode: Press this button when the tuner is in use to select between automatic tuning and manual tuning. When the button is pressed so that the **AUTO** indicator **X** goes out, pressing the **Tuning** buttons **21 8 E** will move the frequency up or down in single-step increments. When the FM band is in use, pressing this button when a station's signal is weak will change to monaural reception. (See page 29 for more information.)

Main Remote Control Functions

20 Direct Button: Press this button when the tuner is in use to start the sequence for direct entry of a station's frequency. After pressing the button simply press the proper **Numeric Keys 18** to select a station. (See page 29 for more information on the tuner.)

21 Tuning Up/Down: When the tuner is in use, these buttons will tune up or down through the selected frequency band. If the **Tuner Mode** button **19 12** has been pressed so that the **AUTO** indicator **X** is illuminated, pressing and holding either of the buttons for three seconds will cause the tuner to seek the next station with acceptable signal strength for quality reception. When the **AUTO** indicator **X** is NOT illuminated, pressing these buttons will tune stations in single-step increments. (See page 29 for more information.)

22 OSD Button: Press this button to activate the On Screen Display (OSD) system used to set up or adjust the AVR 310's parameters.

23 Macro Buttons: Press these buttons to store or recall a "Macro", which is a pre-programmed sequence of commands stored in the remote. (See page 36 for more information on storing and recalling macros.)

24 Transport Controls: These buttons do not have any functions for the AVR 310, but they may be programmed for the forward/reverse play operation of a wide variety of CD or DVD players, and audio or video cassette recorders. (See page 38 for more information on programming the remote.)

25 Skip Up/Down Buttons: These buttons do not have a direct function with the AVR 310, but when used with a compatibly programmed CD or DVD changer they will change the disc currently being played in the changer.

26 Disc Skip Buttons: These buttons have no direct function for the AVR 310, but they are often used when the remote is programmed to operate a CD or DVD changer to change the discs in the changer. (See page 37 for more information on using the remote with other devices.)

27 Preset Up/Down: When the tuner is in use, press these buttons to scroll through the stations programmed into the AVR 310's mem-

ory. When some source devices, such as CD players, VCRs and cassette decks, are selected using the device **Input Selectors 5**, these buttons may function as chapter step or track advance.

28 Clear Button: Press this button to clear incorrect entries when using the remote to directly enter a radio station's frequency.

29 Memory Button: Press this button to enter a radio station into the AVR 310's preset memory. Once the **MEMORY** indicator **U** flashes, you have five seconds to enter a preset memory location using the **Numeric Keys 18**. (See page 30 for more information.)

30 Delay/Prev Ch.: Press this button to begin the process for setting the delay times used by the AVR 310 when processing surround sound. After pressing this button, the delay times are entered by pressing the **Set** button **16** and then using the **▲/▼** buttons **14** to change the setting. Press the **Set** button again to complete the process. (See page 20 for more information.)

31 ► Button: Press this button to change a setting or selection when configuring many of the AVR 310's settings.

32 Speaker Select: Press this button to begin the process of configuring the AVR 310's Bass Management System for use with the type of speakers used in your system. Once the button has been pressed, use the **▲/▼** buttons **14** to select the channel you wish to set up. Press the **Set** button **16** and then select another channel to configure. When all adjustments have been completed, press the **Set** button **16** twice to exit the settings and return to normal operation. (See page 21 for more information.)

33 Multi-Room: Press this button to activate the multiroom system or to begin the process of changing the input or volume level for the second zone. (See page 34 for more information on the multiroom system.)

34 Volume Up/Down: Press these buttons to raise or lower the system volume.

35 TV/Video Button: This button does not have a direct function on the AVR 310, but when used with a compatibly programmed VCR, DVD or satellite receiver that has a "TV/Video" function, pressing this button will switch between the output of the player or receiver and the external video input to that player. Consult the Owner's Manual for your specific player or receiver for the details of how it implements this function.

36 SPL Indicator Select: This button activates the AVR 310's EzSet function to quickly and accurately calibrate the AVR 310's output levels. Press and hold the button for three seconds and then release it. Note that the Test Tone will begin circulating, and the **Program Indicator 3** will change colors. During this sequence, EzSet will automatically adjust the output levels for all channels until they are equal, as shown by the **Program Indicator** lighting green for each channel. Press this button again when the adjustment is complete to turn off the test tone. (See page 23 for more information on EzSet.)

37 6-Ch. Direct Input: Press this button to select the component connected to the **6-Channel Direct Input 9** as the source.

38 Mute: Press this button to momentarily silence the AVR 310 or TV set being controlled, depending on which device has been selected.

When the AVR 310 remote is being programmed to operate another device, this button is pressed with the **Input Selector** button **5** to begin the programming process. (See page 35 for more information on programming the remote.)

39 EzSet Sensor Microphone: The sensor microphone for the EzSet microphone is behind these slots. When using the remote to calibrate speaker output levels using EzSet, be sure that you do not hold the remote in a way that covers these slots. (See page 23 for more information on using EzSet.)

Zone II Remote Control Functions

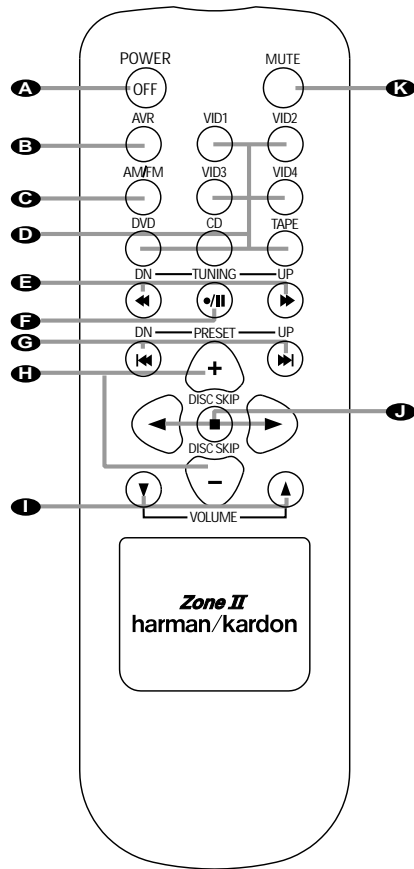

A Power Off: When used in the room where the AVR 310 is located, press this button to place the unit in Standby. When it is used in a remote room with a sensor that is connected to the **Multi IR** jack ⑫, this button turns the Multi-Room system on and off.

B AVR Selector: Press this button to turn on the AVR 310. The input in use when the unit was last on will be selected.

C AM/FM Tuner Select: Press this button to select the Tuner as the input to the Multiroom system. Press it again to change between the AM and FM bands.

D Input Selectors: When the AVR 310 is off, press one of these buttons to select a specific input and turn the unit on. When the unit is already in use, pressing one of these buttons will change the input.

E Tuning Up/Down – Fast Play: When this remote is used in the same room as the AVR 310, these buttons may be used to change the frequency of the tuner. These buttons may also control the Fast Play or Fast Reverse functions of compatible Harman Kardon CD, DVD or cassette decks in the same room, or from a remote room when an IR link is connected to the AVR 310.

F Record/Pause: Press this button to activate the Record or Pause function on compatible Harman Kardon CD, DVD or Cassette Deck products.

G Preset Up/Down – Track Skip: When the AVR 310's tuner is selected as the input source, these buttons will move up or down through the list of stations that have been stored in the preset memory. When a CD or DVD player is selected, these buttons activate the forward or reverse track or chapter skip functions.

H Disc Skip: Press this button to change discs on compatible Harman Kardon CD or DVD players.

I Volume Up/Down: When used in the room where the AVR 310 is located, press this button to raise or lower the volume in that room. When it is used in a remote room with a sensor that is connected to the **Multi IR** Jack ⑫, this button will raise or lower the volume in the remote room.

J Play Forward/Reverse/Stop: Press these buttons to control compatible Harman Kardon CD, DVD or cassette players.

Mute: When used in the room where the AVR 310 is located, press this button to temporarily silence the unit. When it is used in a remote room with a sensor that is connected to the **Multi IR** Jack ⑫, this button will temporarily silence the feed to the remote room only. Press the button again to return to the previous volume level.

- A** Power Off
- B** AVR Selector
- C** AM/FM Tuner Select
- D** Input Selectors
- E** Tuning Up/Down – Fast Play
- F** Record/Pause
- G** Preset/Track Skip
- H** Disc Skip
- I** Volume Up/Down
- J** Play Forward/Reverse/Stop
- Mute**

NOTE: The Zone II remote may be used in either the same room where the AVR 310 is located, or it may be used in a separate room with an optional infrared sensor that is connected to the AVR 310's **Multi IR** input jack ⑫. When it is used in the same room as the AVR 310, it will control the functions of the AVR 310 or any compatible Harman Kardon products in that room. When it is used in a separate room via a sensor connected to the **Multi IR** Jack ⑫, the buttons for power, input source,

volume and mute will control the source and volume for the second zone, as connected to the Multi Out Jacks ⑩. (See page 34 for complete information on using the Multiroom system.)

Installation and Connections

System Installation

After unpacking the unit, and placing it on a solid surface capable of supporting its weight, you will need to make the connections to your audio and video equipment.

Audio Equipment Connections

We recommend that you use high-quality interconnect cables when making connections to source equipment and recorders to preserve the integrity of the signals.

When making connections to audio source equipment or speakers it is always a good practice to unplug the unit from the AC wall outlet. This prevents any possibility of accidentally sending audio or transient signals to the speakers that may damage them.

1. Connect the analog output of a CD player to the **CD** inputs **8**.

NOTE: When the CD player has both fixed and variable audio outputs it is best to use the fixed output unless you find that the input to the receiver is so low that the sound is noisy, or so high that the signal is distorted.

2. Connect the analog Play/Out jacks of a cassette deck, MD, CD-R or other audio recorder to the **Tape Input** jacks **1**. Connect the analog Record/In jacks on the recorder to the **Tape Output** jacks **2** on the AVR 310.

3. Connect the output of any digital sources to the appropriate input connections on the AVR 310 rear panel. Note that the **Optical** and **Coaxial** digital inputs **28 29 13 15** may be used with a Dolby Digital or DTS source or the output of a conventional CD or LD player's PCM (S/P-DIF) output.

4. Connect the **Coaxial or Optical Digital Outputs** **30** on the rear panel of the AVR to the matching digital input connections on a CD-R or MiniDisc recorder.

5. Assemble the AM Loop Antenna supplied with the unit as shown below. Connect it to the **AM** and **GND** screw terminals **4**.

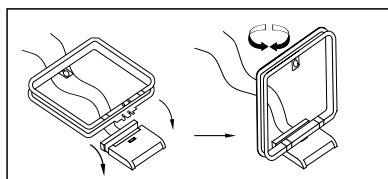

6. Connect the supplied FM antenna to the **FM** (75 ohm) connection **7**. The FM antenna may be an external roof antenna, an inside powered or wire lead antenna or a connection from a cable TV system. Note that if the antenna or connection uses 300-ohm twin-lead cable, you must use the 300-ohm-to-75-ohm adapter supplied with the unit to make the connection.

7. Connect the front, center and surround speaker outputs **14 15** to the respective speakers.

To assure that all the audio signals are carried to your speakers without loss of clarity or resolution, we suggest that you use high-quality speaker cable. Many brands of cable are available and the choice of cable may be influenced by the distance between your speakers and the receiver, the type of speakers you use, personal preferences and other factors. Your dealer or installer is a valuable resource to consult in selecting the proper cable.

Regardless of the brand of cable selected, we recommend that you use a cable constructed of fine, multistrand copper with a gauge of 14 or smaller. Remember that in specifying cable, the lower the number, the thicker the cable.

Cable with a gauge of 16 may be used for short runs of less than ten feet. We do not recommend that you use cables with an AWG equivalent of 18 or higher due to the power loss and degradation in performance that will occur.

Cables that are run inside walls should have the appropriate markings to indicate listing with UL, CSA or other appropriate testing agency standards. Questions about running cables inside walls should be referred to your installer or a licensed electrical contractor who is familiar with the NEC and/or the applicable local building codes in your area.

When connecting wires to the speakers, be certain to observe proper polarity. Remember to connect the "negative" or "black" wire to the same terminal on both the receiver and the speaker. Similarly, the "positive" or "red" wire should be connected to like terminals on the AVR 310 and speaker.

NOTE: While most speaker manufacturers adhere to an industry convention of using black terminals for negative and red ones for positive, some manufacturers may vary from this configuration. To assure proper phase and optimal

performance, consult the identification plate on your speaker or the speaker's manual to verify polarity. If you do not know the polarity of your speaker, ask your dealer for advice before proceeding, or consult the speaker's manufacturer.

We also recommend that the length of cable used to connect speaker pairs be identical. For example, use the same length piece of cable to connect the front-left and front-right or surround-left and surround-right speakers, even if the speakers are a different distance from the AVR 310.

8. Connections to a subwoofer are normally made via a line level audio connection from the **Subwoofer Output** **1** to the line-level input of a subwoofer with a built-in amplifier. When a passive subwoofer is used, the connection first goes to a power amplifier, which will be connected to one or more subwoofer speakers. If you are using a powered subwoofer that does not have line-level input connections, follow the instructions furnished with the speaker for connection information.

Video Equipment Connections

Video equipment is connected in the same manner as audio components. Again, the use of high-quality interconnect cables is recommended to preserve signal quality.

1. Connect a VCR's or other video source's audio and video Play/Out jacks to the **Video 1** or **Video 2 In** jacks **3 25 27 32** on the rear panel. The Audio and Video Record/In jacks on the VCR should be connected to the **Video 1** or **Video 2 Out** jacks **5 23 26 33** on the AVR 310.

2. Connect the analog audio and video outputs of a satellite receiver, cable TV converter or television set or any other video source to the **Video 3** **24 31** jacks.

3. Connect the analog audio and video outputs of a DVD or laser disc player to the **DVD** jacks **6 22**.

4. Connect the digital audio outputs of a DVD player, satellite receiver, cable box or HDTV converter to the appropriate **Optical** or **Coaxial Digital Inputs** **28 29 13 15**.

5. Connect the **Video Monitor Output** **18** jacks on the receiver to the composite or S-Video input of your television monitor or video projector.

Installation and Connections

Video Connection Note:

- Composite and S-Video signals may only be viewed in their native formats. S-Video inputs may only be viewed when the AVR 310 is connected to a TV set or video display with S-Video capability.

System and Power Connections

The AVR 310 is designed for flexible use with multiroom systems, external control components and power amplifiers.

Main Room Remote Control Extension

If the receiver is placed behind a solid or smoked glass cabinet door, the obstruction may prevent the remote sensor from receiving commands. In this event, an optional remote sensor may be used. Connect the output of the remote sensor to the **Remote IR Input** jack 20.

If other components are also prevented from receiving remote commands, only one sensor is needed. Simply use this unit's sensor or a remote eye by running a connection from the **Remote IR Output** jack 19 to the Remote IR Input jack on Harman Kardon or other compatible equipment.

Multiroom IR Link

The remote room IR receiver should be connected to the AVR 310 via standard coaxial cable. Plug the IR connection cable into the **Multiroom IR Input** jack 21 on the AVR 310's rear panel.

If other Harman Kardon compatible source equipment is part of the main room installation, the **Remote IR Output** jack 19 on the rear panel should be connected to the IR IN jack on source equipment. This will enable the remote room location to control source equipment functions.

NOTE: All remotely controlled components must be linked together in a daisy chain. Connect the **IR OUT** jack of one unit to the **IR IN** of the next to establish this chain.

Multiroom Audio Connections

Depending on the distance from the AVR 310 to the remote room, two options are available for audio connection:

Option 1: Use high-quality, shielded audio interconnect cable from the AVR 310's location to the remote room. At the remote room, connect the interconnect cable to a stereo power amplifier. The amplifier will be connected to the room's speakers. No volume control is required, as the AVR 310 and the remote IR link will provide that function. At the AVR 310, plug the audio interconnect cables into the **Multi-Room Output** jacks 10 on the AVR 310's rear panel.

NOTE: The remote power amplifier must have signal-sensing capability or be left on constantly to assure automatic operation at the remote room.

Option 2: Place the amplifier that will provide power to the remote location speakers in the same room as the AVR 310, and connect the **Multiroom Output** jacks 10 on the rear panel of the AVR 310 to the audio input of the remote room amplifier. Use the appropriate speaker wire to connect the optional power amplifier to the remote speakers. High-quality wire of at least AWG14 is recommended for long multiroom connections.

IMPORTANT NOTE: Any cables run inside walls should be CL3/FT4 rated, or carry any other certification that is required by the NEC or state and local building and electrical codes. To avoid interference, audio and speaker cables should not be parallel to, or run in the same conduits or path with, AC cables. If you have any questions about multiroom wiring, consult your dealer, custom installer or low-voltage electrical contractor.

External Audio Power Amplifier Connections

If desired, the AVR 310 may be connected to optional, external audio power amplifiers.

When an external amplifier is used, connect the **Preamp Output** jacks 11 to the inputs on the external amplifier. Note that when external amplifiers are used, the volume control is still controlled by the AVR 310, although additional volume controls on the external device may impact the volume settings and output levels from the AVR 310.

External Audio Decoder Connection

To provide for ultimate flexibility, the AVR 310 may be used in conjunction with optional, external decoders for digital audio systems other than the AVR 310's own built-in Dolby Digital and DTS decoding system or with DVD players using the DVD Audio Format. If an external decoder is used, connect the output jacks of the decoder to the **6-Channel Direct** inputs 9, making sure to match channels.

These jacks may also be used for connections to devices such as DVD players or High Definition Television (HDTV) sets or decoders that feature built-in digital surround decoders. Although the digital decoding system in the AVR 310 will typically provide audio performance that is superior to other decoders, you may use these jacks to provide an additional 6-channel input for connection to a DVD player or HDTV set with a built-in decoder and discrete 6-channel analog outputs.

AC Power Connections

This unit is equipped with two accessory AC outlets. They may be used to power accessory devices, but they should not be used with high-current draw equipment such as power amplifiers. The total power draw to each outlet may not exceed 100 watts.

The **Switched AC Accessory** 16 outlet will receive power only when the unit is on. This is recommended for devices that have no power switch or a mechanical power switch that may be left in the "ON" position.

NOTE: Many audio and video products go into a Standby mode when they are used with switched outlets, and cannot be fully turned on using the outlet alone without a remote control command.

The **Unswitched AC Accessory** 17 outlet will receive power as long as the unit is plugged into a powered AC outlet.

Finally, when all connections are complete, plug the power cord into a nonswitched 110-volt AC wall outlet. You're almost ready to enjoy the AVR 310!

System Configuration

When all audio, video and system connections have been made, there are a few configuration adjustments that must be made. A few minutes spent to correctly configure and calibrate the unit will greatly add to your listening experience.

Speaker Selection and Placement

The placement of speakers in a multichannel home-theater system can have a noticeable impact on the quality of sound reproduced.

No matter which type or brand of speakers is used, the same model or brand of speaker should be used for the front left, center and front right speakers. This creates a seamless front soundstage and eliminates the possibility of distracting sonic disturbances that occur when a sound moves across mismatched front channel speakers.

Speaker Placement

Depending on the type of center channel speaker in use and your viewing device, place the center speaker either directly above or below your TV, or in the center behind a perforated front projection screen.

Once the center channel speaker is installed, position the left front and right front speakers so that they are as far away from one another as the center channel speaker is from the preferred listening position. Ideally, the front channel speakers should be placed so that their tweeters are no more than 24" above or below the tweeter in the center channel speaker.

Depending on the specifics of your room acoustics and the type of speakers in use, you may find that imaging is improved by moving the front left and front right speakers slightly forward of the center channel speaker. If possible, adjust all front loudspeakers so that they are aimed at ear height when you are seated in the listening position.

Using these guidelines, you'll find that it takes some experimentation to find the correct location for the front speakers in your particular installation. Don't be afraid to move things around until the system sounds correct. Optimize your speakers so that audio transitions across the front of the room sound smooth, and that sounds from all speakers appear to arrive at the

listening position at the same time (without delay from the center speaker compared to the left and right speakers).

Surround speakers should be placed on the side walls of the room, at or slightly behind the listening position. The center of the speaker should face into the room. The speakers should be located so that the bottom of the cabinet is at least two feet higher than the listeners' ears when the listeners are seated in the desired area.

If side-wall mounting is not practical, the speakers may be placed on a rear wall, behind the listening position. Again, they should be located so that the bottom of the cabinet is at least two feet higher than the listeners' ears. The speakers should be no more than six feet behind the rear of the seating area.

Subwoofers produce nondirectional sound, so they may be placed almost anywhere in a room. Actual placement should be based on room size and shape and the type of subwoofer used. One method of finding the optimal location for a subwoofer is to begin by placing it in the front of the room, about six inches from a wall, or near the front corner of the room. Another method is to temporarily place the subwoofer at your normal listening position, and then walk around the room until you find a spot where the subwoofer sounds best. Place the subwoofer in that spot. You should also follow the instructions of the subwoofer's manufacturer, or you may wish to experiment with the best location for a subwoofer in your listening room.

System Setup

Once the speakers have been placed in the room and connected, the remaining steps in the setup process are to program the AVR 310's bass management system for the type of speakers used in your system, calibrate the output levels, and set the delay times used by the surround sound processor.

You are now ready to power up the AVR 310 to begin these final adjustments.

1. Plug the **Power Cable**  into an unswitched AC outlet.

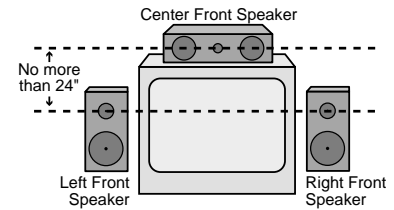

A) Front Channel Speaker Installation with Direct-View TV Sets or Rear-Screen Projectors

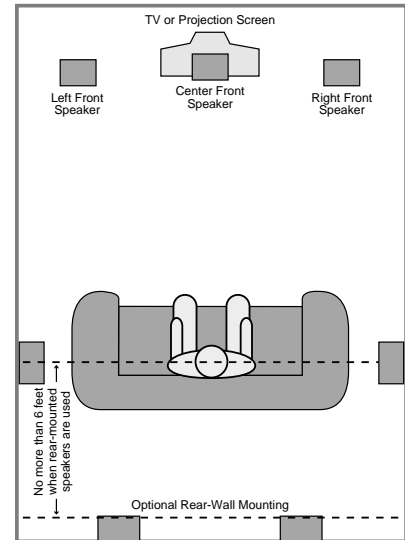

B) The distance between the left and right speakers should be equal to the distance from the seating position to the viewing screen. You may also experiment with placing the left and right speakers slightly forward of the center speaker.

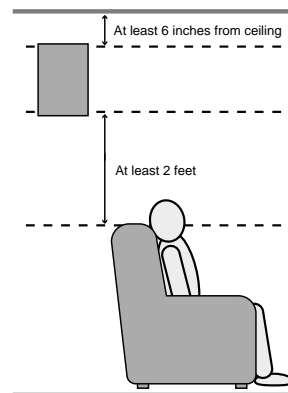

System Configuration

2. Press the **Main Power Switch** **1** in until it latches and the word "OFF" on the top of the switch disappears inside the front panel. Note that the **Power Indicator** **3** will turn amber, indicating that the unit is in the Standby mode.
3. Remove the protective plastic film from the front-panel lens. If left in place, the film may affect the performance of your remote control.
4. Install the three supplied AAA batteries in the remote as shown. Be certain to follow the (+) and (-) polarity indicators that are on the bottom of the battery compartment.

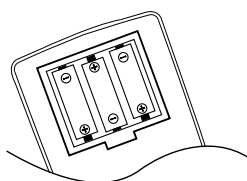

5. Turn the AVR 310 on either by pressing the **System Power Control** **2** on the front panel, or via the remote by pressing the **AVR Selector** **6** or any of the **Input Selectors** **5** **7** on the remote. The **Power Indicator** **3** will turn green to confirm that the unit is on, and the **Main Information Display** **25** will also light.

Using the On-Screen Display

When making the following adjustments, you may find it easier to use the AVR 310's on-screen display system. These easy-to-read displays give you a clear picture of the current status of the unit and make it easy to see which speaker, delay, input or digital selection you are making.

To view the on-screen menus, make certain you have made a connection from the **Video Monitor Out** jack **18** on the rear panel to the composite or S-Video input of your TV or projector. In order to view the AVR 310's displays, the correct video source must be selected on the video display.

IMPORTANT NOTE: When viewing the displays on a projection TV it is important that they not be left on the screen for an extended period of time. As with any video display, but particularly with projectors, constant display of a static image such as these menus or video game images may cause the image to be permanently "burned into" the CRT. This type of damage is not covered by the AVR 310 warranty and may not be covered by the projector TV set's warranty.

The AVR 310 has two on-screen display modes, "Semi-OSD" and "Full-OSD." When making configuration adjustments, it is recommended that the Full-OSD mode be used. This will place a complete status report or option listing on the screen, making it easier to view the available options. The Semi-OSD mode uses one-line displays only.

Making Configuration Adjustments

The full OSD system is always available by pressing the OSD button **22**. When this button is pressed, the **AUDIO SETUP** menu (Figure 1) will appear, and adjustments are made from the individual menus. The semi-OSD system is also available as a system default, although it may be turned off by using the **ADVANCED SELECT** menu. (See page 32.) With the semi-OSD system, you may make adjustments directly, by pressing the buttons on the front panel or remote control for the specific parameter to be adjusted. For example, press the **Speaker Select** button **27** to set the speaker configuration, etc.

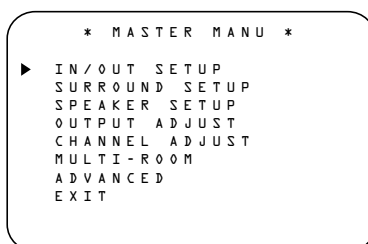

Figure 1

Note that when the full OSD system is in use, the menu selections are not shown in the **Main Information Display** **25** **Y**. When the full OSD menu system is used, OSD ON will appear in the **Main Information Display** **Y** and the **OSD Indicator** **M** will illuminate to remind you that a video display must be used. When the semi-OSD system is used in conjunction with the discrete configuration buttons, the on-screen display will show a single line of text with the current menu selection. That selection will also be shown in the **Main Information Display** **Y**.

To use the full OSD menu system, press the **OSD** button **22**. When the menu is on the screen, press the **▲/▼** buttons **14** until the on-screen **▶** cursor is next to the item you wish to adjust, and then press the **Set** button **16** to adjust that item. Note that the menus will remain on the screen for 20 seconds, and then they will "time-out" and disappear from the screen. The time-out may be increased to as

much as 50 seconds by going to the **ADVANCED SELECT** menu, and changing the item titled **FULL OSD TIME OUT**.

Setting the System Configuration Memories

The AVR 310 features an advanced memory system that enables you to establish different configurations for the speaker configuration, digital input, surround mode, delay times, crossover frequency and output levels for each input source. This flexibility enables you to custom-tailor the way in which you listen to each source and have the AVR 310 memorize those settings. This means, for example, that you may use different output levels or trims for different sources, or set different speaker configurations with the resultant changes to the bass management system. Once these settings are made, they will automatically be recalled whenever you select that input.

The factory default settings for the AVR 310, have all inputs configured for an analog source, stereo as the surround mode, the front left and right speakers set to "large," and a subwoofer connected. Before using the unit, you will probably want to change the settings for most inputs so that they are properly configured to reflect the use of digital or analog inputs, the type of speakers installed and the surround mode specifics. Remember that since the AVR 310 memorizes the settings for each input individually, you will need to make these adjustments for each input used. However, once they are made, further adjustment is only required when system components are changed.

To make this process as quick and as easy as possible, we suggest that you use the full-OSD system with the on-screen menus, and step through each input. Once you have completed the settings for the first input, many settings may be duplicated for the remaining inputs. It is also a good idea to set the configuration data in the order these items are listed in the **AUDIO SETUP** menu, as some settings require a specific entry in a prior menu item. Remember that once the settings are made for one input, they must be made for all other input sources in your system.

System Configuration

Input Setup

The first step in configuring the AVR 310 is to select an input. This may be done by pressing the front panel **Input Source Selector** 11 until the desired input's name appears momentarily in the **Main Information Display** Y, and the green LED lights next to the input's name in the front panel **Input Indicators** 22. The input may also be selected by pressing the appropriate Input Selector on the remote control 5 7.

When using the full-OSD system to make the setup adjustments, press the **OSD** button 22 once so that the main **AUDIO SETUP** menu (Figure 1) appears. Note that the ► cursor will be next to the **INPUT SETUP** line. Press the **Set** button 16 to enter the menu and the **IN/OUT SETUP** menu (Figure 2) will appear on the screen. Press the ◀▶ buttons 15 31 until the desired input name appears in the highlighted video, as well as being indicated in the front panel **Input Indicators** 22 by the green LED next to the desired input name. If the input will use the standard left/right analog inputs, no further adjustment is needed.

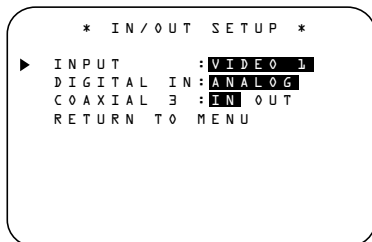

Figure 2

If you wish to associate one of the digital inputs with the selected input source, press the ▼ button 14 on the remote while the **INPUT** select menu (Figure 2) is on the screen, and note that the on-screen cursor will drop down to the **DIGITAL IN** line. Press the ◀▶ buttons 15 31 until the name of the desired digital input appears. To return to the analog input, press the buttons until the word **ANALOG** appears. When the correct input source appears, press the ▼ button 14 once so that the ► cursor appears next to **RETURN TO MENU**, and press the **Set** button 16.

To change the digital input at any time using the discrete function buttons and the semi-OSD system, press the **Digital Input Select** button 24 17 on the front panel or the remote. Within five seconds, make your input selection

using the **Selector** buttons on the front panel 5 or the ▲/▼ buttons 14 on the remote until the desired digital or analog input is shown in the **Main Information Display** Y and in the lower third of the video display connected to the AVR 310. Press the **Set** button 16 to enter the new digital input assignment.

An exclusive Harman Kardon feature is the ability to switch front panel jacks from their normal use as inputs to output connections so that portable recording devices may easily be connected. On the AVR 310, the **Coaxial 3 Digital Jack** 15 is normally an input, but it may also be switched to a digital output for use with CD-R/RW decks, MD recorders or other digital audio recorders. To change the jack to an output, press the ▲/▼ buttons 14 while the **IN/OUT SETUP** menu is on the screen so that the ► cursor is next to **COAXIAL 3**. Then press the ◀▶ buttons 15 31 so that the word **OUT** is highlighted. Note that the **Digital Coax 3 Status Indicator** 14 will turn red, indicating that the jack is now a record output.

NOTE: A signal will be sent to this jack only when the input selected for use by the AVR 310 is digital. Digital signals will be passed through regardless of their format, and which digital input (optical or coax) they are fed from. However, analog signals are not converted to digital, and the format of the signal (e.g., PCM, Dolby Digital or DTS) may not be changed.

Selection of the Digital Coax 3 jack as an output will remain effective as long as the AVR 310 is on. However, once the unit is turned off, the jack will revert to its normal use as an input when the unit is turned on again.

Surround Setup

Once the basic input setup has been completed, the next step is to set the surround mode you wish to use with an input. Since surround modes are a matter of personal taste, feel free to select any mode you wish – you may change it later. However, to make it easier to establish the initial parameters for the AVR 310, it is best to select Dolby Pro Logic for most analog inputs and Dolby Digital for inputs connected to digital sources. In the case of inputs such as a CD Player, Tape Deck or Tuner, you may wish to set the mode to Stereo (as they are not typically used with multichannel program material), where it is unlikely that surround-encoded material will be used. Alternatively, the

Logic 7 Music mode is a good choice for stereo-only source material.

NOTE: If you have selected Logic 7 C or M as your surround mode for the current listening session, and you are using a digital input, and you have not changed the default surround mode for that input source to the same Logic 7 mode, then you will notice that if the digital signal is interrupted for any reason (such as stopping the source device), upon resumption of the signal, the AVR 310 will use a different surround mode. In fact, the AVR 310 will use whichever mode was set as the default for that source. The factory default for all sources is Stereo mode, unless the receiver detects a Dolby Digital or DTS bitstream.

It is easiest to complete the surround setup using the full-OSD on-screen menus. From the **AUDIO SETUP** menu (Figure 1), press the ▲/▼ buttons 14 until the ► cursor is next to the **SURROUND SETUP** menu. Press the **Set** button 16 so that the **SURROUND SETUP** menu (Figure 3 or 4) is on the screen.

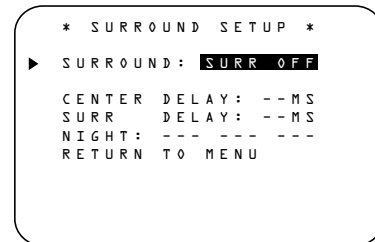

Figure 3

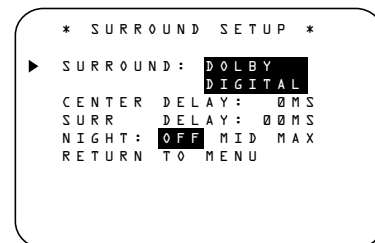

Figure 4

Since the factory default for all inputs is Stereo, the phrase **SURR OFF** will initially appear in highlighted video (Figure 3). To change the surround mode while the ► cursor is next to the surround line, press the ◀▶ buttons 15 31 until the desired surround mode's name appears in the highlighted video. As the modes are changed, a green LED will also light next to the mode names in the **Surround Mode Indicators** 29 on the front panel.

System Configuration

Note that the data lines next to the items in the screen display will show either numbers or a series of dashes, depending on whether or not the specific parameter is adjustable. For example, the Center Delay and Night Mode items are only adjustable for Dolby Digital, and the Delay Time is only adjusted for Dolby Digital and Dolby Pro Logic. Note, also, that Dolby Digital and DTS will only appear as choices (Figure 4) when a digital input was previously selected.

Depending on the surround mode selected, you will now proceed to change either the delay time or the crossover frequency. For Dolby Digital and Dolby Pro Logic, pressing the ▲/▼ **14** buttons on the remote will take you to the delay settings.

Delay Settings

If Dolby Digital or Dolby Pro Logic is selected as the surround mode for an input, you may need to adjust the delay time setting. Note that the delay time is not adjustable for any other modes.

Due to the different distances between the listening position for the front channel speakers and the surround speakers, the amount of time it takes for sound to reach your ears from the front versus surround speakers differs. You may compensate for this difference through the use of the delay settings to adjust the timing for the specific speaker placement and acoustic conditions in your listening room or home theater.

The factory setting is appropriate for most rooms, but some installations create an uncommon distance between the front and surround speakers that may cause the arrival of front channel sounds to become disconnected from surround channel sounds.

To resynchronize the front and surround channels, follow these steps:

1. Measure the distance from the listening position to the front speakers.
2. Measure the distance from the listening position to the surround speakers.
3. Subtract the distance to the surround speakers from the distance to the front speakers.
 - a. When setting the delay time for the Dolby Digital surround modes, the opti-

mal delay time is the result of that subtraction. For example, if the front speakers are ten feet away and the surround speakers are five feet away, the optimal delay time is figured as $10-5=5$. Thus, in this example, the delay time for Dolby Digital should be set at five milliseconds.

- b. When setting the delay time for the Pro Logic mode, take the result of the subtraction and add 15 to obtain the optimal delay time. For example, if the front speakers are ten feet away and the surround speakers are five feet away, the optimal delay time is figured as $10-5+15=20$. Thus, in this example, the Pro Logic delay should be set at twenty milliseconds.

NOTE: The DTS, Logic 7, Hall and Theater modes use a fixed, nonadjustable delay time.

The Dolby Digital Mode also includes a separate setting for the center channel delay mode, since the discrete nature of these signals makes the location of the center channel speaker more critical. To calculate the delay for the center channel, measure the distance from the preferred listening position in the center of the room to both the center channel speaker and either the left or right speaker.

If the distances are equal, no further adjustment is required and the center delay should be set to zero. If the distance to the front speakers is greater than the distance to the center speaker, you may wish to reposition the speakers by moving the front left and front right speakers closer to the listening position or the center speaker further away from the listening position.

If repositioning of the speakers is not possible, adjust the center delay time, adding one millisecond of center channel delay for every foot closer to the listening position the center speaker is than the front speakers. For example, if the front left and front right speakers are each 10 feet from the listening position and the center channel speaker is 8 feet away, the delay is figured as $10-8=2$, suggesting an optimal center delay of 2 milliseconds.

To set the delay time for a specific input, continue within the **SURROUND SETUP** (Figure 4) menu. If the system is not already at that point, press the **OSD** button **22** to bring up the main **AUDIO SETUP** menu, press

the ▼ button **14** and then the **Set** button **16** to bring up the **SURROUND SETUP** menu, and then press the ▼ button **14** once.

If the Dolby Digital mode is selected, the ► cursor will stop at the **CENTER DELAY** line. In that case, press the ◀/▶ buttons **15 31** until the number calculated using the formula shown above appears in the display. When the **CENTER DELAY** is entered, press the ▼ button **14** once to move to the next line.

When the **CENTER DELAY** is set, or if the Dolby Pro Logic mode is selected, the ► cursor will be at the **SURR DELAY** line so that the delay for the surround speakers may be set. Press the ◀/▶ buttons **15 31** until the number calculated using the formula shown above appears in the display. When the delay settings are complete, press the ▼ button **14** once to move to the next line.

Note that the delay settings may also be adjusted at any time when the Dolby Digital or Dolby Pro Logic modes are in use by pressing the **Delay** button on the front panel **23** or remote **30**, followed by a press of the **Set** button **16**. Next, press the ▲/▼ buttons **14** on the remote or the **Selector** buttons **5** on the front panel until the desired figure appears in the **Main Information Display Y**.

Night Mode Settings

The Night mode is a feature of Dolby Digital that uses special processing to preserve the dynamic range and full intelligibility of a movie sound track while reducing the peak level. This prevents abruptly loud transitions from disturbing others, without reducing the sonic impact of a digital source. Note that the Night mode is only available when specially encoded Dolby Digital signals are played.

To adjust the Night mode setting for an input from the menu, make certain that the ► cursor is on the **NIGHT** line of the **SURROUND SETUP** menu. Next, press ◀/▶ buttons **15 31** to choose between the following settings, as they appear in the on-screen display:

OFF: When **OFF** is highlighted, the Night mode will not function.

MID: When **MID** is highlighted, a mild compression will be applied.

System Configuration

MAX: When **MAX** is highlighted, a more severe compression algorithm will be applied.

We recommend that you select the **MID** setting as a starting point and change to the **MAX** setting later, if desired.

Note that the Night mode may be adjusted directly any time that a Dolby Digital source is playing by pressing the **Night** button **12**. When the button is pressed, the phrase **D-RANGE** will appear in the lower third of the video screen and in the **Main Information Display** **Y**. Press the **▲/▼** button **14** within three seconds to select the desired setting.

When all settings for the surround setup have been made, press the **▲/▼** buttons **14** so that the **▶** cursor is next to **RETURN TO MENU**, and press the **Set** button **16** to return to the main menu.

Speaker Setup

This menu tells the AVR 310 which type of speakers are in use. This is important as it adjusts the settings that determine which speakers receive low frequency (bass) information. For each of these settings use the **LARGE** setting if the speakers for a particular position are traditional full-range loudspeakers that are capable of reproducing sounds below 100Hz. Use the **SMALL** setting for smaller, frequency-limited satellite speakers that do not reproduce sounds below 100Hz. Note that when “small” speakers are used, a subwoofer is required to reproduce low frequency sounds. Remember that the “large” and “small” descriptions do not refer to the actual physical size of the speakers, but to their ability to reproduce low frequency sounds. If you are in doubt as to which category describes your speakers, consult the specifications in the speakers’ owner’s manual, or ask your dealer.

It is easiest to enter the proper settings for the speaker setup through the **SPEAKER SETUP** menu (Figure 5). If that menu is not already on your screen from the prior adjustments, press the **OSD** button **22** to bring up the main **AUDIO SETUP** menu (Figure 1), and then press the **▼** button **14** twice so that the cursor is on the **SPEAKER SETUP** line. At this point, press the **Set** button **16** to bring up the **SPEAKER SETUP** menu (Figure 5).

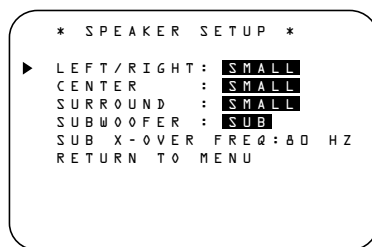

Figure 5

When the **SPEAKER SETUP** menu first appears, the on-screen cursor **▶** will be at the top of the list of speaker positions, pointing toward the **LEFT/RIGHT** line, which sets the configuration for the front left and right speakers. If you wish to make a change to the front speakers configuration, press the **◀▶** buttons **15 31** so that either **LARGE** or **SMALL** appears, matching the appropriate description from the definitions shown above.

When **SMALL** is selected, low frequency sounds will be sent only to the subwoofer output. Note that if you choose this option and there is no subwoofer connected, you will not hear any low frequency sounds from the front channels.

When **LARGE** is selected, a full-range output will be sent to the front left and front right outputs. Depending on the choice made in the **SUBWOOFER** line in this menu, bass information may also be directed to the front left/right speakers, a subwoofer or both.

When you have completed your selection for the front channel, press the **▼** button **14** on the remote to move the cursor to **CENTER**.

Press the **◀▶** buttons **15 31** on the remote to select the option that best describes your system based on the speaker definitions shown below.

When **SMALL** is selected, low frequency center channel sounds will be sent only to the subwoofer output. Note that if you choose this option and there is no subwoofer connected, you will not hear any low frequency sounds from the center channel speaker.

When **LARGE** is selected, a full-range output will be sent to the center speaker output, and **NO** center channel signal will be sent to the subwoofer output.

NOTE: If you choose Logic 7 as the surround mode for the particular input source for which you are configuring your speakers, the AVR 310

will not make the **LARGE** option available for the center speaker. This is due to the requirements of Logic 7 processing, and does not indicate a problem with your receiver.

When **NONE** is selected, no signals will be sent to the center channel output. The receiver will operate in a “phantom” center channel mode and center channel information will be sent to the left and right front channel outputs. When only front left and right speakers are used, with no center or surround speakers, **VMAX** is a good alternative mode.

When you have completed your selection for the center channel, press the **▼** button **14** on the remote to change the cursor to **SURROUND**.

Press the **◀▶** buttons **15 31** on the remote to select the option that best describes the surround speakers in your system based on the speaker definitions shown on this page.

When **SMALL** is selected, low frequency surround channel sounds will be sent to the subwoofer output only. Note that if you choose this option and there is no subwoofer connected, you will not hear any low frequency sounds from the surround speakers.

When **LARGE** is selected, a full-range output will be sent to the surround channel outputs, and **NO** surround channel signals will be sent to the subwoofer output.

When **NONE** is selected, surround sound information will be split between the front-left and front-right outputs. Note that for optimal performance when no surround speakers are in use, the Dolby 3 Stereo mode should be used instead of Dolby Pro Logic.

When you have completed your selection for the surround channel, press the **▼** button **14** on the remote to move the cursor to **SUBWOOFER**.

Press the **◀▶** buttons **15 31** on the remote to select the option that best describes your system.

The choices available for the subwoofer position will depend on the settings for the other speakers, particularly the front left/right positions.

If the front left/right speakers are set to **SMALL**, the subwoofer will automatically be set to **SUB**, which is the “on” position.

System Configuration

If the front left/right speakers are set to **LARGE**, three options are available:

- If no subwoofer is connected to the AVR 310, press the ◀▶ buttons **15 31** on the remote so that **NONE** appears in the on-screen menu. When this option is selected, all bass information will be routed to the front left/right “main” speakers.
- If a subwoofer is connected to the AVR 310, you have the option to have the front left/right “main” speakers reproduce bass frequencies at all times, and have the subwoofer operate only when the AVR 310 is being used with a digital source that contains a dedicated Low Frequency Effects, or LFE soundtrack. This allows you to use both your main and subwoofer speakers to take advantage of the special bass created for certain movies, press ◀▶ buttons **15 31** on the remote so that **SUB (LFE)** appears in the on-screen menu.
- If a subwoofer is connected and you wish to use it for bass reproduction in conjunction with the main front left/right speakers, regardless of the type of program source or surround mode you are listening to, press the ◀▶ buttons **15 31** on the remote so that **SUB LFE+L/R** appears in the on-screen menu. When this option is selected, a “complete” feed will be sent to the front left/right “main” speakers, and the subwoofer will receive the bass frequencies under frequency selected in the next option setting on this menu, as described below.

When you have completed your selection for the subwoofer, press the ▼ button **14** on the remote to change the cursor to **SUB X-OVER FREQ**. The subwoofer crossover setting may only be adjusted using the on-screen display system.

At this line you will select the frequency at which bass information is directed to the **Subwoofer Output 1**. The choices available will depend on the setting made previously for the front left/right speakers. When making these selections, choose the crossover frequency that is closest to that of your front left/right speakers, or the upper frequency limit of your subwoofer. This figure is normally printed in the Owner’s Manual or data sheet for the speakers, or consult the speaker’s manufacturer.

- When the front speakers have been set to **LARGE**, the crossover choices are **40**

Hz or **60 Hz** to match the typical crossover points of full range speakers. Choose the option that is closest to your speakers’ design.

- When the front speakers have been set to **SMALL**, the crossover choices are **80 Hz** or **100 Hz** to match the typical crossover points of the smaller speakers used in satellite speaker systems. Choose the option that is closest to your speakers’ design.

When all speaker selections have been made, press the ▼ button **14** and then the **Set** button **16** to return to the main menu.

The Speaker Configuration may also be changed at any time without using the full-OSD on-screen menu system by pressing the **Speaker Select** button on the front panel **27** or remote **32**. Once the button is pressed, **FNT SPEAKER** will appear in both the lower third of the video display and the **Main Information Display Y**.

Within three seconds, either press the front panel ◀▶ Selector buttons **5** or the ▲/▼ buttons **14** on the remote to select a different speaker position, or press the **Set** button **21 16** to begin the adjustment process for the front left and right speakers.

When the **Set** button **21 16** has been pressed and the system is ready for a change to the speaker setting, the on-screen display and **Main Information Display Y** will read **FNT LARGE** or **FNT SMALL**, depending on the current setting. Press the front panel ◀▶ Selector Buttons **5** or the ▲/▼ buttons **14** on the remote until the desired setting is shown, using the instructions for “large” or “small” shown earlier.

If the configuration for another speaker position needs to be changed, press the front panel ◀▶ Selector buttons **5** or the ▲/▼ buttons **14** on the remote to select a different speaker position, and then press the front panel ◀▶ Selector buttons **5** or the ▲/▼ buttons **14** on the remote until the correct speaker setting is shown.

To assist in making speaker configuration settings, the icons in the **Speaker/Channel Input Indicators Q** change as the speaker type is selected at each position. When only the center icon box containing the abbreviation for the speaker position is lit, the speaker is set for

“small.” When the inner box and the two outer boxes with circles inside them are lit, the speaker is set for “large.” When no indicator appears at a speaker location, that position is set for “none” or “no” speaker.

NOTE: These icons are available only when making setup changes in the semi-OSD mode.

As an example, in Figure 6 below, the left front and right front speakers are set for “large,” the center, left surround (LS) and right surround (RS) speakers are set for small, and a subwoofer is set, as shown by the box with the abbreviation “LFE”, which stands for “low-frequency effects.”

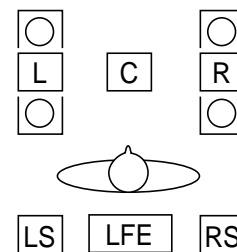

Figure 6

Output Level Adjustment

Output level adjustment is a key part of the configuration process for any surround sound product. It is particularly important for a Dolby Digital receiver such as the AVR 310, as correct outputs will ensure that you hear sound tracks with the proper directionality and intensity.

IMPORTANT NOTE: Listeners are often confused about the operation of the surround channels. While some assume that sound should always be coming from each speaker, most of the time there will be little or no sound in the surround channels. This is because they are only used when a movie director or sound mixer specifically places sound there to create ambience, a special effect or to continue action from the front of the room to the rear. When the output levels are properly set it is normal for surround speakers to operate only occasionally. Artificially increasing the volume to the rear speakers may destroy the illusion of an enveloping sound field that duplicates the way you hear sound in a movie theater or concert hall.

System Configuration

Before beginning the output level adjustment process, make certain that all speaker connections have been properly made. The system volume should be set to the level that you will use during a typical listening session. Finally, make certain that the **Balance Control 18** is set to the center “12 o'clock” position.

Using EzSet

Harman Kardon's exclusive EzSet remote makes it possible to quickly and accurately set the AVR 310's output levels without the use of a sound pressure meter, although manual adjustment is also available. However, for the easiest set-up, follow these steps while seated in the listening position that will be used most often:

1. Make certain that all speaker positions have been properly configured for their “large” or “small” settings (as outlined above) and turn off the OSD system if it is in use.
2. Adjust the volume so that it is at **-15**, as shown in the on-screen display or **Main Information Display Y**.
3. Hold the remote in front of you at arm's length, being sure not to cover the EzSet Sensor Microphone **39** at the top of the remote.
4. Press and hold the **SPL Indicator Select 36** for three seconds. Release the button when the **Program/SPL Indicator 3** stops flashing and you hear the test noise from the front left speaker.
5. At this point, the EzSet circuitry will take over, adjusting the output level of each channel so that when the process is complete all levels will be equal and at the set reference point. This process may take a few minutes, depending on the extent of adjustment required.
6. During the adjustment you will see the location of the channel position being adjusted appear in both the on-screen display (if connected) and the **Main Information Display Y**, alternating with a readout of the output setting, relative to the reference volume level. As the adjustment proceeds, a few things will happen simultaneously:
 - The channel position being adjusted will flash in the **Speaker/Channel Position Indicators Q**. If the test noise is heard from a channel other than the one shown

in the Indicator, there is an error in the speaker connections. If this is the case, press the **Test Button 9** TWICE to stop the adjustment. Then, turn the unit off and verify that all speakers are connected to the proper **Outputs 14/15**.

- As each channel is set, the channel name and the adjustment offset will appear in the on-screen display (if connected) and the **Main Information Display Y**. While the level is changing, the **Program/SPL Indicator 3** will change colors to reflect the output level in relation to the reference. A red indication shows that the level is too high, while an amber indication shows that the level is too low. When the Indicator is green, the level is correct, and the test noise will move to the next channel.
 - While adjustments are being made, the red LED under the **AVR Selector 6** will flash. This is normal, and indicates that EzSet is operating.
7. After the test noise has circulated once through each channel, it will send the tone to each channel once again, to verify the settings.
 8. After two complete circulations of the tone, the levels are set. The **Program Indicator 3** will remain green at each channel. Upon completion of the second circulation, the Program/SPL Indicator will flash green twice and then go out. The tone will stop and the AVR 310 will return to normal operation.

If you find that the output levels chosen by EzSet are either uncomfortably low or high, you may repeat the procedure. Return to Step 2 above and adjust the master volume either slightly higher or lower to accommodate your particular room layout and your tastes. You may repeat this procedure as many times as necessary to achieve a desired result. In order to prevent possible damage to your hearing or your equipment, we emphasize that you should avoid setting the master volume above 0dB.

Manual Output Level Adjustment

Output levels may also be adjusted manually, either to set them to a specific level with an SPL meter, or to make fine tuning adjustments to the levels obtained using the EzSet remote.

Manual output level adjustment is most easily done through the **OUTPUT ADJUST** menu (Figure 7). If you are already at the main

menu, press the **▼ button 14** until the on-screen **► cursor** is next to the **OUTPUT ADJUST** line. If you are not at the main menu, press the **OSD button 22** to bring up the main **AUDIO SETUP** menu (Figure 1), and then press the **▼ button 14** three times so that the on-screen **► cursor** is next to the **OUTPUT ADJUST** line. Press the **Set button 16** to bring the **OUTPUT ADJUST** menu (Figure 7) to the screen.

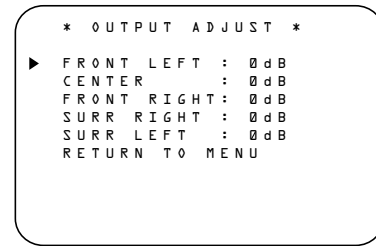

Figure 7

As soon as the new menu appears, you will hear a test noise circulate from speaker to speaker in a clockwise direction around the room. The test noise will play for two seconds in each speaker before circulating, and a blinking on-screen cursor will appear next to the name of each speaker location when the sound is at that speaker.

NOTE: Remember to verify that the speakers have been properly connected. As the test noise circulates, listen to make certain that the sound comes from the speaker position shown in the **Main Information Display Y**. If the sound from a speaker location does NOT match the position indicated in the display, turn the AVR 310 off using the **Main Power Switch 1** and check the speaker wiring to make certain that each speaker is connected to the correct output terminal.

After checking for speaker placement, let the test noise circulate again, and listen to see which channels sound louder than the others. Using the front left speaker as a reference, press the **◀▶ buttons 15/31** on the remote to bring all speakers to the same volume level. Note that when one of the **◀▶ buttons** is pushed, the test noise circulation will pause on the channel being adjusted to give you time to make the adjustment. When you release the button, the circulation will resume after five seconds.

System Configuration

Continue to adjust the individual channels until the volume level sounds the same from each speaker. Note that adjustments should be made with the ◀▶ buttons 15 31 on the remote only, NOT the main volume controls. If you are using a sound pressure level (SPL) meter for precise level adjustment, set the volume so that the meter reads 75dB, C-Weighting Slow.

You may also adjust the output levels manually while using the level indication feature of the EzSet remote. To activate the sensor and indicator, simply press and release the **SPL Indicator Select** button 36 on the remote while the test tone is circulating. The **Program/SPL Indicator** 3 will change color to indicate the level. Adjust the level using the ◀▶ buttons 15 31 until the LED lights green for all channels. When it is red the level is too high; when it is amber the level is too low. Press the **SPL Indicator Select** 36 button when you are finished to turn the sensor and Indicator off.

NOTE: The subwoofer output level is not adjustable using the test tone. To change the subwoofer level, follow the steps for Output Level Trim Adjustment on page 30.

When all channels have an equal volume level, the adjustment is complete. To exit this menu, press the ▲/▼ buttons 14 until the on-screen ► cursor is next to the **RETURN TO MENU** line, and then press the **Set** button 16 to return to the main **AUDIO SETUP** menu.

The output levels may also be adjusted at any time using the discrete buttons and semi-OSD system. To adjust the output levels in this fashion, press the **Test Tone Selector** 28 9. As soon as the button is pressed, the test tone will begin to circulate as indicated earlier. The correct channel from which the test noise should be heard will be shown in the lower third of the video screen and in the **Main Information Display** Y. While the test noise is circulating, the proper channel position will also be indicated in the **Speaker/Channel Indicators** Q by a blinking letter within the correct channel.

To adjust the output level, press the **Selector** buttons on the front panel 5 or the ◀▶ buttons 15 31 until the desired level is shown in the display or on screen. Once the buttons are released, the test noise will begin to circulate again in five seconds.

When all channels have the same output level, press the **Test Tone Selector** 28 9 button again to complete the process.

NOTE: Output level adjustment is not available for the VMAx or Surround Off mode.

Additional Input Adjustments

After one input has been adjusted for surround mode, digital input (if any), speaker type, and output levels, go back to the **INPUT SETUP** line on the **AUDIO SETUP** menu and enter the settings for each input that you will use. In most cases, only the digital input and surround mode will be different from one input to the next, while the speaker type, crossover frequency, night mode and output level settings will usually be the same and may be quickly entered by entering the same data used for the original input.

Once the settings outlined on the previous pages have been made, the AVR 310 is ready for operation. While there are some additional settings to be made, these are best done after you have had an opportunity to listen to a variety of sources and different kinds of program material. These advanced settings are described on pages 27 to 31 of this manual. In addition, any of the settings made in the initial configuration of the unit may be changed at any time. As you add new or different sources or speakers, or if you wish to change a setting to better reflect your listening taste, simply follow the instructions for changing the settings for that parameter as shown in this section.

Having completed the setup and configuration process for your AVR 310, you are about to experience the finest in music and home-theater listening. Enjoy!

Operation

Basic Operation

Once you have completed the setup and configuration of the AVR 310, it is simple to operate and enjoy. The following instructions will help you maximize the enjoyment of your new receiver:

Turning the AVR 310 On or Off

- When using the AVR 310 for the first time, you must press the **Main Power Switch 1** on the front panel to turn the unit on. This places the unit in a Standby mode, as indicated by the amber color of the **Power Indicator 3**. Once the unit is in Standby, you may begin a listening session by pressing the **System Power Control 2** on the front panel or the **AVR Selector 6**. Note that the **Power Indicator 3** will turn green. This will turn the unit on and return it to the input source that was last used. The unit may also be turned on from Standby by pressing any of the **Input Selector** buttons on the remote (**5 6 7 B C D**) or the **Source** button **11** on the front panel.

NOTE: After pressing one of the **Input Selector** buttons (**5 7**) to turn the unit on, press the **AVR Selector 6** to set the remote control to the AVR 310 functions.

To turn the unit off at the end of a listening session, simply press the **System Power Control 2** on the front panel or the **Power Off** button (**4 A**) on the remote. Power will be shut off to any equipment plugged into the rear panel **Switched AC Outlets 16** and the **Power Indicator 3** will turn amber.

When the remote is used to turn the unit "off" it is actually placing the system in a Standby mode, as indicated by the amber color of the **Power Indicator 3**.

- To program the AVR 310 for automatic turn-off, press the **Sleep** button **10** on the remote. Each press of the button will increase the time before shut down in the following sequence:

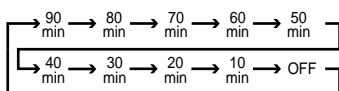

The sleep time will be displayed in the **Preset Number/Sleep Timer Indicator R** and it will count down until the time has elapsed.

When the programmed sleep time has elapsed, the unit will automatically turn off. Note that the front panel display will dim to one half brightness when the Sleep function is programmed. To cancel the Sleep function, press and hold the **Sleep** button **10** until the information display returns to normal brightness, the Sleep indicator numbers disappear and the words **SLEEP OFF** appear in the **Main Information Display Y**.

When you will be away from home for an extended period of time it is always a good idea to completely turn the unit off with the front panel **Main Power Switch 1**.

NOTE: All preset memories are lost if the unit is left turned off by using the **Main Power Switch 1** for more than two weeks.

Source Selection

- To select a source, press any of the **Source Selector** buttons on the remote (**5 7 C D**).

- The input source may also be changed by pressing the front-panel **Input Source Selector** button **11**. Each press of the button will move the input selection through the list of available inputs.

- As the input is changed, the AVR 310 will automatically switch to the digital input (if selected), surround mode, speaker configuration, output levels, crossover frequency and night mode status that were entered during the configuration process for that source.

- The front-panel **Video 4 Inputs 16** may be used to connect a device such as a video game or camcorder to your home entertainment system on a temporary basis.

- As the input source is changed, the new input name will appear momentarily as an on-screen display in the lower third of the video display. The input name will also appear in the **Main Information Display Y** and a green LED will light next to the selected input's name in the front-panel **Input Indicators 22**.

Video 1 and Video 2

- When an audio source is selected, the last video input used remains routed to the **Video**

Outputs 23 and **Video Monitor Output 18**. This permits simultaneous viewing and listening to different sources.

- When a Video source is selected, the video signal for that input will be routed to the **Video Monitor Output** jack **18** and will be viewable on a TV monitor connected to the AVR 310.

Volume Control

- Adjust the volume to a comfortable level using the front panel **Volume Control 20** or remote **Volume Up/Down 34 1** buttons.

- When listening in the Stereo mode, with the surround circuits off, the **Balance Control 18** may be used to adjust the relative sound output between the left front and right front speakers.

- To temporarily silence all speaker outputs press the **Mute** button **38 K**. This will interrupt the output to all speakers and the headphone jack, but it will not affect any recording or dubbing that may be in progress. When the system is muted, the **MUTE** indicator **Z** will light in the **Main Information Display 25**. Press the **Mute** button **38 K** again to return to normal operation.

- During a listening session you may wish to adjust the **Bass Control 17** and **Treble Control 19** to suit your listening tastes or room acoustics.

- To set the output of the AVR 310 so that the output is "flat," with the tone controls deactivated, press the **Tone Mode** button **6** button once or twice so that the words **Tone Out** appear momentarily in the **Main Information Display Y**. To return the tone controls to an active condition, press the **Tone Mode 6** button once or twice so that the words **Tone In** momentarily appear in the **Main Information Display Y**.

- For private listening, plug the 1/4" stereo phone plug from a pair of stereo headphones into the front panel **Headphone Jack 4**. Note that when the headphone's plug is connected, the word **HEADPHONE** will scroll once across the **Main Information Display Y** and all speakers will be silenced. When the headphone plug is removed, the audio feed to the speakers will be restored.

Operation

Surround Mode Chart

MODE	FEATURES	DELAY TIME RANGE
DOLBY DIGITAL	Available only with digital input sources encoded with Dolby Digital data. It provides up to five separate main audio channels and a special dedicated Low-Frequency Effects channel.	Center: 0 ms – 5 ms Initial Setting – 0 ms Surround: 0 ms – 15 ms Initial Setting – 0 ms
DTS	Available only with digital input sources encoded with DTS data. Available on special DVD, LD and audio-only discs, DTS provides up to five separate main audio channels and a special dedicated low frequency channel.	Delay time not adjustable
DOLBY PRO LOGIC	The standard mode for analog surround-sound decoding. It uses information encoded in a two-channel stereo recording to produce four distinct outputs: Left, Center, Right and a Mono Surround channel. Use this mode for accurate reproduction of programs bearing the Dolby Surround, DTS Stereo, UltraStereo or other "Surround" logos. Surround-encoded programs include videocassette, DVD and LD movies, TV and cable programs, radio programs and audio CDs. Dolby Pro Logic processing may also be used to provide a pleasing surround effect with some stereophonic source material that does not carry surround encoding.	15 ms – 30 ms Initial Setting = 15 ms
LOGIC 7 C LOGIC 7 M	Logic 7 is an advanced mode that extracts the maximum surround information from either surround-encoded programs or conventional stereo material. The Logic 7 C or Cinema mode should be used with any source that contains Dolby Surround or similar matrix encoding. Logic 7 C delivers increased center-channel intelligibility, and more accurate placement of sounds with fades and pans that are much smoother and more realistic than with other decoding techniques. The Logic 7 M or Music mode should be used with analog or PCM stereo sources. Logic 7 M enhances the listening experience by presenting a wider front soundstage and greater rear ambience. Both Logic 7 modes also direct low-frequency information to the subwoofer (if installed and configured) to deliver maximum bass impact.	Delay time not adjustable
DOLBY 3 STEREO	Uses the information contained in a surround-encoded or two-channel stereo program to create center-channel information. In addition, the information that is normally sent to the rear-channel surround speakers is carefully mixed in with the front-left and front-right channels for increased realism. Use this mode when you have a center-channel speaker but no surround speakers.	No surround channels
THEATER	Surround processing uses matrix surround decoding to simulate a standard movie or stage theater.	Delay time not adjustable
HALL 1 HALL 2	The two Hall modes offer two different matrix surround decoding choices that simulate either a medium-sized chamber hall (Hall1) or a large concert hall or opera house (Hall 2)	Delay time not adjustable
VMAx Near VMAx Far	When only the two front channel loudspeakers are used, Harman's patented VMAx mode delivers a three-dimensional sound space with the illusion of "phantom speakers" at the center and surround positions. The VMAx N, or "Near Field" mode should be selected when your listening position is less than five feet from the speakers. The VMAx F, or "Far Field" mode should be selected when your listening position is greater than five feet from the speakers.	No surround channels
5-Channel Stereo	This mode takes advantage of multiple speakers to place a stereo signal at both the front and back of a room. Ideal for playing music in situations such as a party, it places the same signal at the front-left and surround-left, and front-right and surround-right speakers. The center channel is fed a summed mono mix of the in-phase material of the left and right channels.	No delay is available for this mode
SURROUND OFF (STEREO)	This mode turns off all surround processing and presents the pure left- and right-channel presentation of two-channel stereo programs.	No surround channels

Operation

Surround Mode Selection

One of the most important features of the AVR 310 is its ability to reproduce a full multichannel surround-sound field from digital sources, analog matrix surround-encoded programs and standard stereo programs. In all, a total of thirteen listening modes are available on the AVR 310.

Selection of a surround mode is based on personal taste, as well as the type of program source material being used. For example, motion pictures or TV programs bearing the logo of one of the major surround-encoding processes, such as Dolby Surround, DTS Stereo or UltraStereo^{††} may be played in either the Dolby Digital, Dolby Pro Logic or Logic 7 Cinema surround modes depending on the source material.

NOTE: Once a program has been encoded with matrix surround information, it retains the surround information as long as the program is broadcast in stereo. Thus, movies with surround sound may be decoded via any of the analog surround modes such as Pro Logic or Logic 7, when they are broadcast via conventional TV stations, cable, pay TV and satellite transmission. In addition, a growing number of made-for-television programs, sports broadcasts, radio dramas and music CDs are also recorded in surround sound. You may view a list of these programs at the Dolby Laboratories Web site at www.dolby.com.

Even when a program is not listed as carrying intentional surround information, you may find that the Pro Logic, Logic 7, VMaX and the Hall or Theater modes often deliver enveloping surround presentations through the use of the natural information present in all stereo recordings. However, for stereo, but not surround programs, we suggest that you experiment with the other modes.

Surround modes are selected using either the front panel controls or the remote. To select a surround mode from the front panel, press the **Surround Mode Selector** **7** to scroll up or down through the list of available modes. To select a surround mode using the remote, press the **Surround Mode Selector** **11** and then press the **▲/▼** buttons **14** to change the mode. As you press the buttons, the Surround mode name will appear in the **Main Information Display** **Y**, and an individual mode indicator will also light up **CDFHI JKLN**. As the surround modes change, a

green LED will light next to the current mode in the **Surround Mode Indicators** list **29** on the front panel.

Note that the Dolby Digital and DTS modes may only be selected when a digital input is in use. In addition, when a digital source is present, the AVR 310 will automatically select and switch to the correct mode (Dolby Digital or DTS), regardless of the mode that has been previously selected. For more information on selecting digital sources, see the following section of this manual.

To listen to a program in traditional two-channel stereo, using the front-left and front-right speakers only (plus the subwoofer if installed and configured), follow the instructions shown above for using the remote until **SURR OFF** appears in the **Main Information Display** **Y**.

Digital Audio Playback

Digital audio is a major advancement over older systems such as Dolby Pro Logic. It delivers five discrete channels: left-front, center, right-front, left-surround and right-surround. Each channel reproduces full frequency range (20Hz to 20kHz) and offers dramatically improved dynamic range and significant improvements to signal-to-noise ratios. In addition, digital systems have the capability to deliver an additional channel that is specifically devoted to low-frequency information. This is the “.1” channel referred to when you see these systems described as “5.1”. The bass channel is separate from the other channels, but since it is intentionally bandwidth-limited, sound designers have given it that unique designation.

Dolby Digital

Dolby Digital (originally known as AC-3[®]) is a standard part of DVD, and is available on specially encoded LD discs and satellite broadcasts and it is a part of the new high-definition television (HDTV) system.

Note that an optional, external RF demodulator is required to use the AVR 310 to listen to the Dolby Digital sound tracks available on laser discs. Connect the RF output of the LD player to the demodulator and then connect the digital output of the demodulator to the **Optical** or **Coaxial** inputs **28/29/13/15** of the AVR 310. No demodulator is required for use with DVD players or DTS-encoded laser discs.

DTS

DTS is another digital audio system that is capable of delivering 5.1 audio. Although both DTS and Dolby Digital are digital, they use different methods of encoding the signals, and thus they require different decoding circuits to convert the digital signals back to analog.

DTS-encoded sound tracks are available on select DVD and LD discs, as well as on special audio-only DTS discs. You may use any LD or CD player equipped with a digital output to play DTS-encoded discs with the AVR 310. All that is required is to connect the player's output to either the **Optical** or **Coaxial** input on the rear panel **28/29** or front panel **13/15**.

In order to listen to DVDs encoded with DTS sound tracks, the DVD player must be compatible with the DTS signal as indicated by a DTS logo on the player's front panel. Note that early DVD players may not be able to play DTS-encoded DVDs. This does not indicate a problem with the AVR 310, as some players cannot pass the DTS signal through to the digital outputs. If you are in doubt as to the capability of your DVD player to handle DTS discs, consult the player's owner's manual.

Selecting a Digital Source

To utilize either digital mode you must have properly connected a digital source to the AVR 310. Connect the digital outputs from DVD players, HDTV receivers, satellite systems or CD players to the **Optical** or **Coaxial** inputs **28/29/13/15**. In order to provide a backup signal and a source for analog stereo recording, the analog outputs provided on digital source equipment should also be connected to their appropriate inputs on the AVR 310 rear panel (e.g., connect the analog stereo audio output from a DVD to the **DVD Audio** inputs **6** on the rear panel when you connect the source's digital outputs).

When playing a digital source such as DVD, first select the input using the remote or front panel controls as outlined in this manual. Next, select the digital source by pressing the **Digital Input Selector** button **17/24** and then using the **▲/▼** buttons **14** on the remote or the **Selector** buttons **5** on the front panel to choose any of the **OPTICAL** or **COAXIAL** inputs, as they appear in the **Main Information Display** **Y** Display Indicator **B/E** or on-screen display. When the digital

Operation

source is playing, the AVR 310 will automatically detect whether it is a multichannel Dolby Digital, DTS source, MP3 or a conventional PCM signal, which is the standard output from CD players. A **Bitstream Indicator A** will light in the **Main Information Display 25** to confirm that the digital signal is Dolby Digital, DTS or PCM.

Digital Status Indicators

When a digital source is playing, the AVR 310 senses the type of bitstream data that is present. Using this information, the correct surround mode will automatically be selected. For example, DTS bitstreams will cause the unit to switch to DTS decoding, and Dolby Digital bitstreams will enable Dolby Digital decoding. When the unit senses PCM data from CDs and LDs, it will allow the appropriate surround sources to be selected manually. Since the range of available surround modes is dependant on the type of digital data that is present, the AVR 310 uses a variety of indicators to let you know what type of signal is present. This will help you to understand the choice of modes.

When a digital source is playing, a **Bitstream Indicator A** will light to show which type of signal is playing:

DOLBY D: When the DOLBY D indicator lights, a Dolby Digital bitstream is being received. Depending on the settings on the source player and specific surround information and number of channels on the disc, a number of surround modes are possible. For discs with full 5.1 audio, only the Dolby Digital and VMAx modes are available. When the Dolby Digital signal is only two-channel, you may also select from the Logic 7 Cinema/Music, Hall, Theater, Dolby Pro Logic or Dolby 3 Stereo modes.

DTS: When the DTS indicator lights, a DTS bitstream is being received. When the unit senses this type of data, only the DTS mode may be used.

PCM: When the PCM indicator lights, a standard Pulse Code Modulation, or PCM, signal is being received. This is the type of digital audio used by conventional compact disc and laser disc recordings. When a PCM bitstream is present, all modes except Dolby Digital and DTS are available.

MP3: When the MP3 indicator lights, a compatible MPEG 1/Layer 3 digital signal is being received. This is the popular audio format used by many computer programs for recording compressed audio files. When an MP3 bitstream is present, the sound will automatically be played in the stereo (surround off) mode. The surround modes are not available during MP3 playback.

In addition to the bitstream indicators, the AVR 310 features a set of unique channel-input indicators that tell you how many channels of digital information are being received and/or if the digital signal is interrupted.

These indicators are the L/C/R/LS/RS/LFE letters that are inside the center boxes of the **Speaker/Channel Input Indicators Q** in the front panel **Main Information Display 25**. When a standard analog signal is in use, only the "L" and "R" indicators will light, as analog signals have only left and right channels, respectively.

Digital signals, however, may have two, five or six separate channels, depending on the program material, the method of transmission and the way in which it was encoded. When a digital signal is playing, the letters in these indicators will light in response to the specific signal being received. It is important to note that although Dolby Digital, for example, is referred to as a "5.1" system, not all Dolby Digital DVDs or programs are encoded for 5.1. Thus, it is sometimes normal for a DVD with a Dolby Digital soundtrack to trigger only the "L" and "R" indicators.

NOTE: Many DVD discs are recorded with both "5.1" and "2.0" versions of the same soundtrack. When playing a DVD, always be certain to check the type of material on the disc. Most discs show this information in the form of a listing or icon on the back of the disc jacket. When a disc does offer multiple soundtrack choices you may have to make some adjustments to your DVD player (usually with the "Audio Select" button or in a menu screen on the disc) to send a full 5.1 feed to the AVR 310. It is also possible for the type of signal feed to change during the course of a DVD playback. In some cases the previews of special material will only be recorded in 2.0 audio, while the main feature is available in 5.1 audio. As long as your DVD player is set for 6-channel output, the AVR 310 will automatically sense changes to the bitstream and channel count and reflect them in these indicators.

The letters used by the **Speaker/Channel Input Indicators Q** also flash to indicate when a bitstream has been interrupted. This will happen when a digital input source is selected before the playback starts, or when a digital source such as a DVD is paused. The flashing indicators remind you that the playback has stopped due to the absence of a digital signal and not through any fault of the AVR 310. This is normal, and the digital playback will resume once the playback is started again.

Night Mode

A special feature of Dolby Digital is the Night mode, which enables AC-3 input sources to be played back with full digital intelligibility while reducing the minimum peak level by 1/4 to 1/3. This prevents abruptly loud transitions from disturbing others, without reducing the impact of the digital source. The Night mode is available only when Dolby Digital signals with special data are being played.

The Night mode may be engaged when a Dolby Digital DVD is playing by pressing the **Night Mode Button 12** on the remote. Next, press the **▲/▼ buttons 14** to select either the middle range or full compression versions of the Night mode. To turn the Night mode off, press the **▲/▼ buttons 14** until the message in the lower third of the video display and the **Main Information Display Y** reads **D - Range Off**. When the Night mode is active, the **Night Mode Indicator Q** will also illuminate.

The Night mode may also be selected to always be on at either level of compression using the options in the Surround Setup Menu. See page 21 for information on using the menus to set this option.

IMPORTANT NOTES ON DIGITAL PLAYBACK:

1. When the digital playback source is stopped, or in a pause, fast forward or chapter search mode, the digital audio data will momentarily stop, and the channel position letters inside the **Speaker/Channel Input Indicators Q** will flash. This is normal and does not indicate a problem with either the AVR 310 or the source machine. The AVR 310 will return to digital playback as soon as the data is available and when the machine is in a standard play mode.

2. Although the AVR 310 will decode virtually all DVD movies, CDs and HDTV sources, it is possible

Operation

that some future digital sources may not be compatible with the AVR 310.

3. Note that not all digitally encoded programs contain full 5.1-channel audio. Consult the program guide that accompanies the DVD or laser disc to determine which type of audio has been recorded on the disc. The AVR 310 will automatically sense the type of digital surround encoding used and adjust to accommodate it.

4. When a digital source is playing, you may not be able to select some of the analog surround modes such as Dolby Pro Logic, Dolby 3, Stereo, Hall, Theater or Logic 7.

5. When a Dolby Digital or DTS source is playing, it is not possible to make an analog recording using the **Tape 2** and **Video 1** or **Video 2 Record Outputs 5 23 26 33**. However, the digital signals will be passed through to the digital audio outputs **30**.

PCM Audio Playback

PCM (Pulse Code Modulation) is the non-compressed digital audio system used for compact discs and laser discs. The digital circuits in the AVR 310 are capable of high-quality digital-to-analog decoding, and they may be connected directly to the digital audio output of your CD or LD player.

Connections may be made to either the rear panel **Optical** or **Coaxial** inputs **28 29** or the front panel **Digital Inputs 13 15**.

To listen to a PCM digital source, first select the input for the desired source (e.g., CD). Next press the **Digital Select** button **24 17** and then use the **▲/▼** buttons **14** on the remote, or the **Select** buttons **5** on the front panel, until the desired choice appears in the **Main Information Display Y**.

When a PCM source is playing, the **PCM** indicator **A** will light. During PCM playback you may select any surround mode except Dolby Digital or DTS.

Playback from PCM sources may also benefit from the Logic 7 Mode. When playing back a surround-encoded PCM source, such as an LD or surround-encoded CD, use the Logic 7 C or Cinema mode. When playing true stereo recordings, use the Logic 7 M or Music mode for a wider soundstage and increased rear-channel ambience.

NOTE: If you have selected Logic 7 C or M as your surround mode for the current listening session, and you are using a digital input, and you have not changed the default surround mode for that input source to the same Logic 7 mode, then you will notice that if the digital signal is interrupted for any reason (such as stopping the source device), upon resumption of the signal, the AVR 310 will use a different surround mode. In fact, the AVR 310 will use whichever mode was set as the default for that source. The factory default for all sources is Stereo mode, unless the receiver detects a Dolby Digital or DTS bitstream.

MP3 Audio Playback

The AVR 310 is one of the first A/V receivers to provide on-board decoding for the MP3 audio format used by computers and portable audio devices. In addition, some new CD players are capable of playing back optical discs that are recorded with MP3, rather than standard CD audio information. By offering MP3 decoding, the AVR 310 is able to deliver more precise conversion of the digital signals to an analog output, along with the benefits of listening to the MP3 audio through the AVR 310's high current amplifier and the speakers from your surround system, rather than the smaller speakers and low powered amplifiers typically used with computers.

To take advantage of the AVR 310's MP3 capabilities, simply connect the PCM output of a computer's sound card or the PCM output of a portable digital audio device to either the rear panel **Digital Inputs 28 29** or the front panel **Digital Inputs 13 15**. As soon as the digital signal is available, the **MP3 Bitstream Indicator A** will light, and the audio will begin playing.

NOTES:

- The AVR 310 is only capable of playing signals in the MP3 (MPEG 1/Layer 3) format. It is not compatible with other computer audio codecs.
- The digital audio input signal may be either optical or coaxial, but the signal must be in the PCM format. Direct connection of USB or serial data outputs is not possible, even though the signals are in the MP3 format. If you have any questions about the data output format from your computer or a sound card, check with the device's Owner's Manual or contact the manufacturer's technical support area.

Tuner Operation

The AVR 310's tuner is capable of tuning AM, FM and FM Stereo broadcast stations. Stations may be tuned manually, or they may be stored as favorite station presets and recalled from a 30-position memory.

Station Selection

1. Press the **AM/FM Tuner Select** button **7** on the remote to select the tuner as an input. The tuner may be selected from the front panel by either pressing the **Input Source Selector 11** until the tuner is active or by pressing the **Tuner Band Selector 9** at any time.
2. Press the **AM/FM Tuner Select** button **7** or **Tuner Band Selector 9** again to switch between AM and FM so that the desired frequency band is selected.
3. Press the **FM Mode** button **12 19** to select manual or automatic tuning.

When the **AUTO** indicator **X** is illuminated in the **Main Information Display Y** the tuner will only stop at those stations that have a strong enough signal to be received with acceptable quality.

When the **AUTO** indicator **X** is not illuminated, the tuner is in a manual mode and will stop at each frequency increment in the selected band.

4. To select stations, press the **Tuning Selector** button **8 21**. When the **AUTO** indicator **X** is illuminated, press the button for two seconds and then release to cause the tuner to search for the next highest or lowest frequency station that has an acceptable signal. When tuning FM stations in the Auto mode, the tuner will only select stereo stations. To tune to the next station, press the button again. If the **STEREO V** indicator **V** is not illuminated, tap the **Tuning Selector** button **8 21** to advance one frequency increment at a time, or press and hold it to locate a specific station. When the **TUNED W** indicator **W** lights, the station is properly tuned and should be heard with clarity.

5. Stations may also be tuned directly by pressing the **Direct** button **20**, and then pressing the **Numeric Keys 18** that correspond to the station's frequency. The desired station will automatically be tuned. If you press an incorrect button while entering a direct frequency, press the **Clear** button **28** to start over.

Operation

NOTE: When the FM reception of a station is weak, audio quality will be increased by switching to Mono mode by pressing the **FM Mode** button **12** **19** until the **STEREO** indicator **V** goes out.

Preset Tuning

Using the remote, up to 30 stations may be stored in the AVR 310's memory for easy recall using the front panel controls or the remote.

To enter a station into the memory, first tune the station using the steps outlined above. Then:

1. Press the **Memory** button **29** on the remote. Note that the **MEMORY** indicator **U** will be illuminated and flash in the **Main Information Display** **25**.
2. Within five seconds, press the **Numeric Keys** **18** corresponding to the location where you wish to store this station's frequency. Once entered, the preset number will appear in the **Preset Number/Sleep Time Display** **R**.
3. Repeat the process after tuning any additional stations to be preset.

Recalling Preset Stations

- To manually select a station previously entered in the preset memory, press the **Numeric Keys** **18** that correspond to the desired station's memory location.
- To manually tune through the list of stored preset stations one by one, press the **Preset Stations Selector** buttons **10** **27** on the front panel or remote.

Tape Recording

In normal operation, the audio or video source selected for listening through the AVR 310 is sent to the record outputs. This means that any program you are watching or listening to may be recorded simply by placing machines connected to the outputs for **Tape Outputs** **2** or **Video 1** or **2 Outputs** **5** **23** **26** in the record mode.

When a digital audio recorder is connected to the **Digital Audio Outputs** **30**, you are able to record the digital signal using a CD-R, MiniDisc or other digital recording system.

In addition to the rear panel digital outputs, the AVR 310 offers Harman Kardon's exclusive con-

figurable front panel digital output feature. For easy connection of portable digital audio recorders, you may switch the front panel **Coaxial Digital Jack** **15** from an input to an output by following these steps:

1. Press the **OSD** button **22** to view the main **AUDIO SETUP** menu (Figure 1).
2. Press the **Set** button **16** to enter the **IN/OUT SETUP** menu (Figure 2).
3. Press the **▼** button **14** twice so that the on-screen **▶** cursor is next to **COAXIAL 3**.
4. Press the **Set** button **16** and then press either of the **◀/▶** buttons **15** **31** so that the word **IN** is highlighted.
5. Press the **Set** button **16** to enter the change.
6. Press the **OSD** button **22** to exit the menus and return to normal operation.

Note that once the setting is made, the **Digital Coax 3 Status Indicator** **14** will turn red, indicating that the **Coaxial 3 Jack** **15** is now an output, instead of its default setting as an input. Once the jack is changed to an output, the setting will remain as long as the AVR 310 is turned on, unless the setting is changed in the OSD menu system, as described above. Note, however, that once the AVR 310 is turned off, the setting is cancelled. When the unit is turned on again, the **Coaxial 3 Jack** **15** will return to its normal default setting as an input. If you wish to use the jack as an output at a future time, the setting must be changed again using the OSD menu system.

NOTES:

- The digital outputs are active only when a digital signal is present, and they do not convert an analog input to a digital signal, or change the format of the digital signal. In addition, the digital recorder must be compatible with the output signal. For example, the PCM digital input from a CD player may be recorded on a CD-R or MiniDisc, but Dolby Digital or DTS signals may not.
- Please make certain that you are aware of any copyright restrictions on any material you copy. Unauthorized duplication of copyrighted materials is prohibited by federal law.

Output Level Trim Adjustment

Normal output level adjustment for the AVR 310 is established using the test tone, as outlined on pages 22 and 23. In some cases, however, it may be desirable to adjust the output levels using program material such as a test disc, or a selection you are familiar with. Additionally, the output level for the subwoofer can only be adjusted using this procedure.

To adjust the output levels using program material, first set the reference volume for the front-left and front-right channels using the **Volume Control** **20** **34** **1**.

If you are using a disc with test signals or an external signal generator as the source from which to trim the output levels, you may use the EzSet feature of the remote to guide you to the correct SPL level. To use the remote for this purpose, press and quickly release the **SPL Indicator Select** **36** to activate the sensor. While the test tone is circulating, the **Program Indicator** **3** will change color to indicate the level. Adjust the level as shown above until the LED lights green for all channels. When it is red the level is too high; when it is amber the level is too low. Press the **SPL Indicator Select** **36** to turn the sensor and indicator off.

Once the reference level has been set, press the **Channel Select** button **13** **26** and note that **FRONT L LEV** will appear in the **Main Information Display** **Y**. To change the level, first press the **Set** button **16** **21**, and then use the **Selector** buttons **5** or the **▲/▼** buttons **14** to raise or lower the level. DO NOT use the volume control, as this will alter the reference setting.

Once the change has been made, press the **Set** button **16** **21** and then press the **Selector** buttons **5** or the **▲/▼** buttons **14** to select the next output channel location that you wish to adjust. To adjust the subwoofer level, press the **Selector** buttons **5** or the **▲/▼** buttons **14** until **WOOFER LEV** appears in the **Main Information Display** **Y** or on-screen display.

Press the **Set** button **16** **21** when the name of the desired channel appears in the **Main Information Display** **Y** and on-screen display, and follow the instructions shown earlier to adjust the level.

Operation

Repeat the procedure as needed until all channels requiring adjustment have been set. When all adjustments have been made and no further adjustments are made for five seconds, the AVR 310 will return to normal operation.

The channel output for any input may also be adjusted using the full-OSD on-screen menu system. First, set the volume to a comfortable listening level using the **Volume Control 20 34 1**. Then, press the **OSD button 22** to bring up the **AUDIO SETUP** menu (Figure 1). Press the **▼ Button 14** four times until the on-screen ► cursor is next to the **CHANNEL ADJUST** line. Press the **Set Button 16** to activate the **CHANNEL ADJUST** menu (Figure 8).

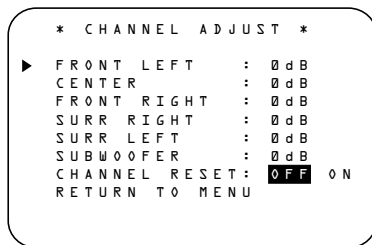

Figure 8

Once the menu appears on your video screen, use the **▲/▼ buttons 14** to move the on-screen ► cursor so that it is next to the channel that you wish to adjust. Then, use the **◀/▶ buttons 15 31** to raise or lower the output level. Remember, the goal is to have the output level at each channel be equal when heard at the listening position.

When all adjustments are done, press the **▲/▼ buttons 14** to move the on-screen ► cursor so that it is next to **RETURN TO MENU** and then press the **Set Button 16** if you wish to go back to the main menu to make other adjustments. If you have no other adjustments to make, press the **OSD button 22** to exit the menu system.

NOTE: The output levels may be separately trimmed for each digital and analog surround mode. If you wish to have different trim levels for a specific mode, select that mode and then follow the instructions in the steps shown earlier.

6-Channel Direct Input

The AVR 310 is equipped for future expansion through the use of optional, external adapters for formats that the AVR 310 may not be capable of processing. When an adapter is connected

to the **6-Channel Direct Input 9**, you may select it by pressing the **6-Ch Direct Input Selector 37**. The 6-Channel Direct Input may also be selected by pressing the **Input Source Selector button 11** on the front panel until the words **6 CH DIRECT** appear in the **Main Information Display 17**, and a green LED lights next to **6 CH** in the **Input Indicators 22**.

Note that when the 6-Channel Direct Input is in use, you may not select a surround mode, as the external decoder determines processing. In addition, there is no signal at the record outputs when the 6-Channel Direct Input is in use.

Memory Backup

This product is equipped with a memory backup system that preserves the system configuration information and tuner presets if the unit is accidentally unplugged or subjected to a power outage. This memory will last for approximately two weeks, after which time all information must be reentered.

Advanced Features

The AVR 310 is equipped with a number of advanced features that add extra flexibility to the unit's operation. While it is not necessary to use these features to operate the unit, they provide additional options that you may wish to use.

Display Brightness

The AVR 310's **Main Information Display** **25** is set at a default brightness level that is sufficient for viewing in a normally lit room. However, in some home theater installations, you may wish to occasionally lower the brightness of the display, or turn it off completely.

To change the display brightness setting for a specific listening session, you will need to make an adjustment in the **ADVANCED SELECT** menu. To start the adjustment, press the **OSD** button **22** to bring the main **AUDIO SETUP** menu to the screen. Press the **▼** Button **14** six times, until the on-screen **▶** cursor is next to the **ADVANCED** line. Press the **Set** Button **16** to enter the **ADVANCED SELECT** menu (Figure 9).

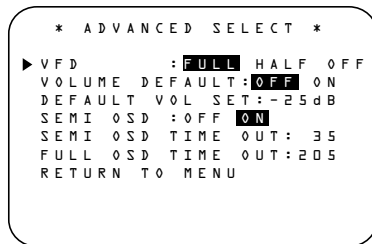

Figure 9

To change the brightness setting, at the **ADVANCED SELECT** menu, make certain that the on-screen **▶** cursor is next to the **VFD** line, and press the **▶** Button **31** until the desired brightness level is highlighted in the video display. When **FULL** is highlighted, the display is at its normal brightness. When **HALF** is highlighted, the display is at half the normal brightness level. When **OFF** is highlighted, all of the indicators in the **Main Information Display** **25** will go dark. Note, however, that the green LEDs for the **Input Indicators** **22** and the **Surround Mode Indicators** **29**, as well as for the **Power Indicator** **3**, will always remain lit to remind you that the unit is turned on.

The display brightness may also be changed by pressing and holding the **Set** button **21** on the front for three seconds until the message in the **Main Information Display** **Y** reads **VFD FULL**. Within five seconds, press the front

panel **Selector** buttons **5** until the desired brightness display level is shown. At that point, press the **Set** button **21** again to enter the setting.

Once the desired brightness level is selected, it will remain in effect until it is changed again or until the unit is turned off.

If you wish to make other adjustments, press the **▲/▼** Buttons **14** until the on-screen **▶** cursor is next to the desired setting or the **RETURN TO MAIN MENU** line and press the **Set** button **16**. If you have no other adjustments to make, press the **OSD** Button **22** to exit the menu system.

Turn-On Volume Level

As is the case with most audio/video receivers, when the AVR 310 is turned on, it will always return to the volume setting in effect when the unit was turned off. However, you may prefer to always have the AVR 310 turn on at a specific setting, regardless of what was last in use when the unit was turned off. To change the default condition so that the same volume level is always used at turn-on, you will need to make an adjustment in the **ADVANCED SELECT** menu. To start the adjustment, press the **OSD** button **22** to bring the main **AUDIO SETUP** menu (Figure 1) to the screen. Press the **▼** button **14** six times, until the on-screen **▶** cursor is next to the **ADVANCED** line. Press the **Set** button **16** to enter the **ADVANCED SELECT** menu (Figure 9).

At the **ADVANCED SELECT** menu make certain that the on-screen **▶** cursor is next to the **VOLUME DEFAULT** line by pressing the **▲/▼** buttons **14** as needed. Next, press the **▶** button **31** so that the word **ON** is highlighted in the video display. Next, press the **▼** button **14** once so that the on-screen **▶** cursor is next to the **DEFAULT VOL SET** line. To set the desired turn-on volume, press the **◀/▶** buttons **15** **31** until the desired volume level is shown on the **DEFAULT VOL SET** line. Note that this setting may NOT be made with the regular volume controls.

NOTE: Since the setting for the turn-on volume cannot be heard while the setting is being made, you may wish to determine the setting before making the adjustment. To do this, listen to any source and adjust the volume to the desired level using the regular volume controls

20 **34** **1**. When the desired volume level to be used at turn-on is reached, make a note of the setting as it appears in the lower third of the video screen or in the **Main Information Display** **Y**. (A typical volume level will appear as a negative number such as -25dB .) When making the adjustment, use the **◀/▶** buttons **15** **31** to enter this setting.

Unlike some of the other adjustments in this menu, the turn-on volume default will remain in effect until it is changed or turned off in this menu, even when the unit is turned off.

If you wish to make other adjustments, press the **▲/▼** Buttons **14** until the on-screen **▶** cursor is next to the desired setting or the **RETURN TO MAIN MENU** line and press the **Set** button **16**. If you have no other adjustments to make, press the **OSD** button **22** to exit the menu system.

Semi-OSD Settings

The semi-OSD system places one line messages at the lower third of the video display screen whenever the Volume, Input Source, Surround mode or tuner frequency of any of the configuration settings are changed. The semi-OSD system is helpful in that enables you to have feedback on any control changes or remote commands using the video display when it is difficult to view the front-panel displays. However, you may occasionally prefer to turn these displays off for a particular listening session. You may also want to adjust the length of time the displays remain on the screen. Both of those options are possible with the AVR 310.

To turn off the semi-OSD system, you will need to make an adjustment in the **ADVANCED SELECT** menu (Figure 9). To start the adjustment, press the **OSD** button **22** to bring the main **AUDIO SETUP** menu to the screen. Press the **▼** Button **14** six times, until the on-screen **▼** cursor is next to the **ADVANCED** line. Press the **Set** Button **16** to enter the **ADVANCED SELECT** menu.

At the **ADVANCED SELECT** menu make certain that the on-screen **▶** cursor is next to the **SEMI OSD DEFAULT** line by pressing the **▲/▼** buttons **14** as needed. Next, press the **▶** Button **31** so that the word **OFF** is highlighted in the video display.

Note that this setting is temporary and will remain active only until it is changed or until the AVR 310 is turned off. Once the unit is

Advanced Features

turned off, the semi-OSD displays will remain activated, even if they were switched off for the previous listening session.

To change the length of time that the semi-OSD displays remain on the screen, go to the **ADVANCED SELECT** Menu as outlined earlier, and press the **▲/▼** buttons **14** as needed, until the on-screen **▶** cursor is next to the **SEMI-OSD TIME OUT** line. Next, press the **◀/▶** Buttons **15/31** until the desired time in seconds is displayed. Note that unlike most of the other options in this menu, this is a permanent setting change, and the time-out entry will remain in effect until it is changed, even when the unit is turned off.

If you wish to make other adjustments, press the **▲/▼** Buttons **14** until the on-screen **▶** cursor is next to the desired setting or the **RETURN TO MAIN MENU** line and press the **Set** button **16**. If you have no other adjustments to make, press the **OSD** Button **22** to exit the menu system.

Full-OSD Time Out Adjustment

The **FULL - OSD** menu system is used to simplify the setup and adjustment of the AVR 310 using a series of on-screen menus. The factory default setting for these menus leaves them on the screen for 20 seconds after a period of inactivity before they disappear from the screen or Time Out. This Time Out is a safety measure to prevent image retention of the menu text in your monitor or projector, which might happen if they were left on indefinitely. However, some viewers may prefer a slightly longer or shorter period before the Time Out display.

To change the Full-OSD Time Out, you will need to make an adjustment in the **ADVANCED SELECT** menu (Figure 9). To start the adjustment, press the **OSD** button **22** to bring the main **AUDIO SETUP** menu to the screen. Press the **▼** button **14** six times, until the on-screen **▼** cursor is next to the **ADVANCED** line. Press the **Set** Button **16** to enter the **ADVANCED SELECT** Menu (Figure 9).

At the **ADVANCED SELECT** menu (Figure 9) make certain that the on-screen **▶** cursor is next to the **FULL - OSD TIME OUT** line by pressing the **▲/▼** Buttons **14** as needed. Next, press the **◀/▶** buttons **15/31** until the desired time is displayed in seconds.

Note that unlike most of the other options in this menu, this is a permanent setting change, and the Time-Out entry will remain in effect until it is changed, even if the unit is turned off.

If you wish to make other adjustments, press the **▲/▼** Buttons **14** until the on-screen **▶** cursor is next to the desired setting or the **RETURN TO MAIN MENU** line and press the **Set** button **16**. If you have no other adjustments to make, press the **OSD** button **22** to exit the menu system.

Multiroom Operation

The AVR 310 is fully equipped to operate as the control center for a multiroom system with optional remote external Infrared (IR) sensors, speakers and power amplifiers. Although some multi-room installations will require the services of a specially trained installer, it is possible for the average do-it-yourself hobbyist to install a simple remote room system.

Installation

The key to remote room operation is to link the remote room to the AVR 310's location with wire for an infrared link and speakers or an amplifier. For installation instructions for Multiroom use, see page 16.

Multiroom Setup

Once the audio and IR link connections have been made, the AVR 310 needs to be configured for multiroom operation using the steps below. Press the **OSD** button **22** to bring the main **AUDIO SETUP** menu (Figure 1) to the screen. Press the **▼** button **14** five times, until the on-screen **▶** cursor is next to the **MULTI-ROOM** line. Press the **Set** button **16** to enter the **MULTI-ROOM SETUP** menu (Figure 10).

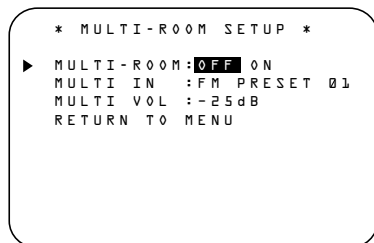

Figure 10

When the **MULTI-ROOM SETUP** menu appears, the on-screen **▶** cursor will be at the **MULTI-ROOM** line. Since this line is used to turn the system on and off, do not make an adjustment here unless you wish to turn the system on at this time. To turn the system on, press the **▶** button **31** so that **ON** is highlighted. If you do not wish to turn the system on at this time or to proceed to the next step, press the **▼** Button **14** once so that the **▶** on-screen cursor is next to the **MULTI IN** line.

At the **MULTI IN** line, press the **◀▶** buttons **15 31** until the desired input to the multiroom system appears in the highlighted video. When the selection has been made, press the **▼** button **14** once so that the **▶** on-screen cursor is next to the **MULTI VOL** line.

At the **MULTI VOL** line, press the **◀▶** buttons **15 31** until the desired volume level for the multi-room system is entered. DO NOT use the regular volume control knobs for this setting. When all settings for the multiroom setup have been made, press the **▲/▼** buttons **14** until the on-screen **▶** cursor is next to the **RETURN TO MAIN MENU** line. If you have no other adjustments to make, press the **OSD** button **22** to exit the menu system.

Multiroom Operation

When operating the AVR 310 from a remote room location where an IR sensor link has been connected to the AVR 310's rear panel **Multiroom IR Input 21**, you may use either the Main remote control or the Zone II remote. To turn on the multiroom feed, press any of the **Input Selector** buttons on the Zone II remote **B C D** or the Main remote **5 6 7**. Press the **AVR Selector 6 B** to turn the unit on to the last source, or any of the other **Selector** buttons to turn on to a specific source.

As long as an IR feed to the AVR 310 has been established from the remote room, using any of the buttons on either remote will control the remote location volume **34 1**, change the tuner frequency **21 C**, change the tuner preset **27 G** or mute the output **33 ●**.

If the **Remote IR Output** jack **18** on the AVR 310 is connected to an IR Input jack on compatible Harman Kardon audio components such as CD, DVD or cassette players, the transport functions of those machines may also be controlled using the **Transport Controls 24 E F G H J** on either remote control.

To turn the system off from the remote room, press the **Power-Off** button **4 A**. Remember that the AVR 310 may be turned on or off from the remote room regardless of the system's operation or status in the main room.

NOTE: When the tuner is selected as the source for the remote zone, any change to the frequency or preset will also change the station being listened to in the main room, if the tuner is in use there. Similarly, if someone in the main room changes the station, the change will also impact the remote room.

To activate the feed to the remote room, while you are in the main listening room where the AVR 310 is located, press the **Multiroom** but-

ton **33** on the remote. Next, press the **Set** button **16**. Press the **▲/▼** buttons **14** to turn the multiroom feed on or off. When the multiroom system is on, the **Multi** indicator **P** will light in the **Main Information Display 25**, and the **Main Information Display Y** or OSD will display **MULTI ON**. Press the **Set** button **16** to enter the setting.

When the multiroom system is turned on, the input selected using the Multi Room menu will be fed to the **Multiroom Output** jacks **10** on the rear panel. The volume will be as set in the previous selection, although it may also be adjusted using an optional IR sensor and the Zone II remote in the remote location or on the optional audio power amplifier connected to the **Multiroom Output** jacks **10**.

Once the multiroom system is turned on, it will remain on even if the AVR 310 is placed in the Standby mode in the main room by pressing the **Power Off** button **A** or the **System Power Control 2** on the front panel. To turn off the multiroom system, even when the AVR is in Standby mode in the main listening room, press the **Multiroom** button **33** and then the **Set** button **16**. Press the **▲/▼** buttons **14** so that the **Multi** indicator **P** in the **Main Information Display 25** goes out, and the **Main Information Display Y** or OSD will display **MULTI OFF**. Press the **Set** button **16** to enter the setting and turn the unit off.

Even when the AVR 310 is turned off in the main room, the multiroom system may be turned on at any time by pressing the **Multiroom** button **33**, or any of the **Selector** buttons **B C D** in the remote room.

Programming the Remote

The AVR 310 is equipped with a powerful remote control that will control not only the receiver's functions, but also most popular brands of audio and video equipment, including CD players, cassette decks, TV sets, cable boxes, VCRs, satellite receivers and other home-theater equipment. Once the AVR 310's remote is programmed with the codes for the products you own, it is possible to eliminate most other remotes and replace them with the convenience of a single, backlit universal remote control.

Programming the Remote

As shipped from the factory, the remote is fully programmed for all AVR 310 functions, as well as those of most Harman Kardon CD changers, DVD players, CD players and cassette decks. In addition, by following one of the methods below, you may program the remote to operate a wide range of devices from other manufacturers.

Direct Code Entry

This method is the easiest way to program your remote to work with different products.

1. Use the tables in the following pages to determine the three-digit code or codes that match both the product type (e.g., VCR, TV), and the specific brand name. If there is more than one number for a brand, make note of the different choices.
2. Turn on the unit you wish to program into the AVR 310 remote.
3. Press and hold both the **Input Selector** **5** for the product you wish to control (e.g., VCR, TV) and the **Mute** button **38** at the same time. When the **Program/SPL Indicator** **3** turns amber and begins flashing, release the buttons. It is important that you begin the next step within 20 seconds.
4. Point the AVR 310's remote towards the unit to be programmed, and enter the first three-digit code number using the **Numeric Keys** buttons **18**. If the unit turns off, the correct code has been entered. Press the **Input Selector** **5** again, and note that the red light will flash three times before going dark to confirm the entry.
5. If the device to be programmed in does NOT turn off, continue to enter three-digit code numbers until the equipment turns off. At this point, the correct code has been entered. Press the **Input Selector** **5** again and note that the red light under the

Input Selector will flash three times before going dark to confirm the entry.

6. Try all of the functions on the remote to make certain that the product operates properly. Keep in mind that many manufacturers use a number of different combinations of codes, so it is a good idea to make certain that not only the Power control, but the volume, channel and transport controls work as they should. If functions do not work properly, you may need to use a different remote code.
7. If a code cannot be entered to turn the unit off, if the code for your product does not appear in the tables in this manual, or if not all functions operate properly, try programming the remote with the Auto Search Method.

Auto Search Method

If the unit you wish to include in the AVR 310's remote is not listed in the code tables in this manual or if the code does not seem to operate properly, you may wish to program the correct code using the Auto Search method that follows:

1. Turn on the unit that you wish to include in the AVR 310 remote.
2. Press the **Input Selector** **5** for the type of product to be entered (e.g., VCR, TV) and the **Mute** button **38** at the same time. Hold both buttons until the red light under the **Input Selector** **5** stays lit. Note that the next step must take place while the red light is on, and it must begin within 20 seconds after the light illuminates.
3. Point the AVR 310 remote towards the unit to be programmed, and press either **▲** or **▼** button **14**. Each press will send out a series of codes from the remote's built-in database. When the unit being programmed turns off, release **▲/▼** button **14**, as that is your indication that the correct code is in use.
4. Press the **Input Selector** **5**, and note that the red light under the Input Selector will flash three times before going dark to confirm the entry.
5. Try all of the functions on the remote to make certain that the product operates. Keep in mind that many manufacturers use a number of different combinations of codes, and it is a good idea to make certain that not only the Power control works, but

also that the volume, channel and transport controls, as appropriate. If all functions do not work properly, you may need to Auto-Search for a different code, or enter a code via the Direct Code Entry method.

Code Readout

When the code has been entered using the Auto Search method, it is always a good idea to find out the exact code so that it may be easily reentered if necessary. You may also read the codes to verify which device has been programmed to a specific Control Selector button.

1. Press and hold both the **Input Selector** **5** for the device you wish to find the code for and the **Mute** button **38** at the same time. Note that the **Program/SPL Indicator** **3** will initially turn amber. Release the buttons and begin the next step within 20 seconds.
2. Press the **Set** button **16**. The **Program/SPL Indicator** **3** will then blink green in a sequence that corresponds to the three-digit code, with a one-second pause between each digit. Count the number of blinks between each pause to determine the digit of the code. One blink is the number 1, two blinks is the number 2, and so forth. Ten blinks are used to indicate a "0."

Example: One blink, followed by a one-second pause, followed by six blinks, followed by a one-second pause, followed by ten blinks indicates that the code has been set to 160.

For future reference enter the Setup Codes for the equipment in your system here:

DVD _____ CD _____
VID1/VCR _____ VID2/TV _____
VID3/CBL/SAT _____
VID4 _____ TAPE _____

Programming the Remote

Learning Codes

In addition to using codes from the remote's internal code library, the AVR 310's remote is able to "learn" codes from remotes that may not be in the code library. In addition, you may use this function to "learn over" the codes from a preprogrammed device to add functions not included in the preprogrammed codes. To learn or transfer codes from an IR remote to the AVR 310's remote, follow these steps:

1. Place the front of the original remote with the code being sent so that it is facing the **IR Transmitter Window 2** on the AVR 310 remote "head-to-head." The remotes should be between one and three inches apart.
2. Select the button on the remote that you wish to use as the device selector for the codes about to be entered. This may be any of the **Input Selectors 5**.
3. Press the **Input Selector 5** button chosen and the **Learn button 8** at the same time. Hold these buttons until the **Program/SPL Indicator 3** flashes amber and the light under the device selector button turns red. Release the buttons.
4. Press the button on the AVR 310 remote that you wish to program. Note that the **Program/SPL Indicator 3** will stop flashing.
5. Within five seconds, press and hold the button on the original remote that you wish to "teach" into the AVR 310 remote. When the **Program/SPL Indicator 3** turns green three times, release the button. Note that the Program Indicator will then begin to flash amber again.

NOTE: If the **Program/SPL Indicator 3** turns red during Step 5 or 6, the programming was not successful. Repeat the steps to see if the code will "take."

6. Repeat Steps 4 through 6 for each button on the source remote that you wish to transfer to the AVR 310 remote.
7. Once all codes have been transferred from the original source remote to the AVR 310 remote, press the **Learn button 8**.

8. Repeat Steps 1 through 7 for any additional remotes you wish to "teach" into the AVR 310 Remote.

Erasing Learned Codes

The AVR 310's remote allows you to remove or erase, the code learned into a single button for a single device, to remove or erase the code set for all the codes that have been programmed into specific device buttons, or to erase all commands that have been learned to all devices.

To erase a single learned code from within a single device's settings, follow these steps:

1. Press and hold both the **Input Selector 5 6 7** within which the individual button to be erased has been programmed and the **Learn button 8**.
2. When the red LED under the **Input Selector** turns red and the **Program/SPL Indicator 3** flashes amber, release the buttons.
3. Press and release the **Input Selector 5 6 7** again for the device within which the individual button to be erased has been programmed.
4. Press the 7 button **18** four times.
5. Press and release the individual button for which the code is to be erased. The **Program/SPL Indicator 3** will blink green two times and then return to amber.
6. To erase other buttons within the same device, press them as noted in Step 5.
7. When all buttons to be erased have been pressed, press the **Learn button 8** to complete the process.

To erase all codes within a single device, follow these steps:

1. Press and hold both the **Input Selector 5 6 7** for which you wish to erase the codes and the **Learn button 8**.
2. When the red LED under the **Input Selector** turns red and the **Program/SPL Indicator 3** flashes amber, release the buttons.
3. Press and release the **Input Selector 5 6 7** again for the device whose codes you wish to erase.
4. Press the 8 button **18** four times.

5. The **Program/SPL Indicator 3** will turn off and the red light under the **Input Selector** will flash on and off once to indicate that the codes have been erased.

To erase all codes that have been programmed to all devices in the remote, follow these steps:

1. Press any **Input Selector 5 6 7** for which you wish to erase the codes and also the **Learn button 8**.
2. When the red LED under the **Input Selector** turns red and the **Program/SPL Indicator 3** flashes amber, release the buttons.
3. Press and release the **Input Selector 5 6 7** again for the device whose codes you wish to erase.
4. Press the 9 button **18** four times.
5. The **Program/SPL Indicator 3** will turn off and the red light under the **Input Selector** will flash on and off once to indicate that the codes have been erased.

Macro Programming

Macros enable you to easily repeat frequently used combinations of commands with the press of a single button on the AVR 310's remote control. Once programmed, a macro will send out up to 19 different remote codes in a pre-determined sequential order enabling you to automate the process of turning on your system, changing devices, or other common tasks. The AVR's remote can store up to five separate macro command sequences, one that is associated with the **Power On button 1**, and four more that are accessed by pressing the **Macro buttons 23**.

1. Press the **Mute button 38** and the **Macro button 23** to be programmed or the **Power-On button 1** at the same time. Note that an **Input Selector** will light red, and the **Program/SPL Indicator 3** will flash amber.
2. Enter the steps for the macro sequence by pressing the button for the actual command step. Although the macro may contain up to 19 steps, each button press, including those used to change devices, counts as a step. The **Program/SPL Indicator 3** will flash green to confirm each button press as you enter commands.

Programming the Remote

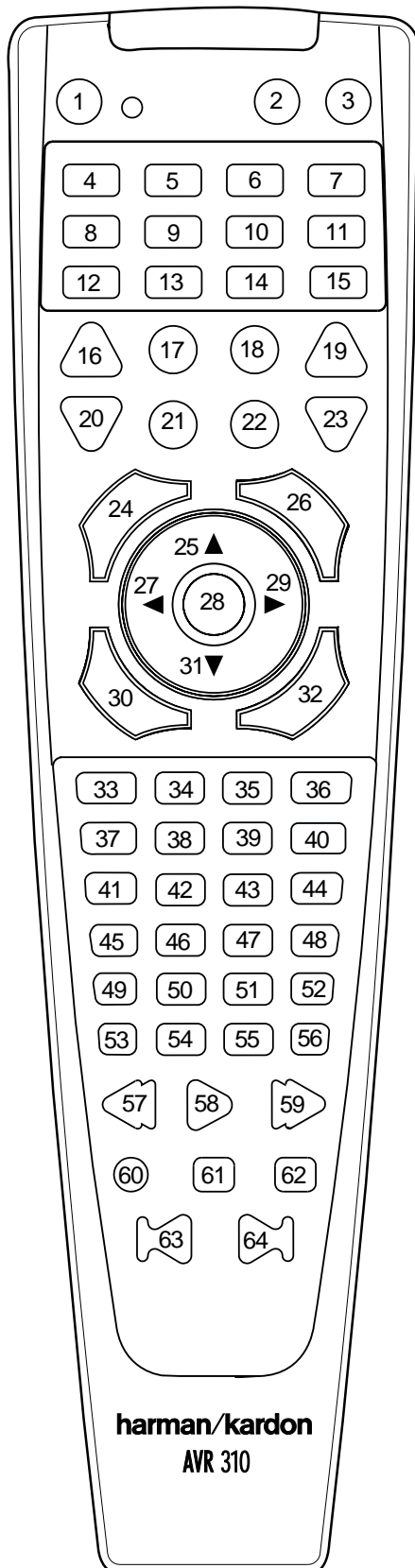

NOTE: While entering commands for Power On/Off of any device during a macro sequence, press the **Mute** button **38**. DO NOT press the actual Power button.

- When all the steps have been entered, press the **Sleep** button **10** to enter the commands. The red light under the **Input Selectors** **5** **6** will blink and then turn off.

Example: To program the Macro 1 button so that it turns on the AVR 310, TV and a Cable Box, follow these steps:

- Press the **Macro 1** button **23** and **Mute** **38** buttons at the same time and then release them.
- Note that the **Program/SPL Indicator** will flash amber.
- Press the **AVR Selector** **6**.
- Press the **Mute** **38** button to store the AVR's power on command.
- Press the **VID 2 Input Selector** button **5** to indicate the next command is for "TV Power On."
- Press the **Mute** **38** button to store the TV Power On Command.
- Press the **VID 3 Input Selector** button **5** to indicate the next command is for "Cable Power On."
- Press the **Mute** **38** button to store the Cable Power On command.
- Press the **Sleep/Channel Up** button **10** to complete the process and store the macro sequence.

After following these steps, each time you press the **Macro 1** button **23**, the remote will send the Power On/Off command.

Erasing Macro Commands

To remove the commands that have been programmed into one of the Macro buttons, follow these steps:

1. Press the **Mute** button **38** and the **Macro** button **23** that contains the commands you wish to erase.
2. Note that the **Program/SPL Indicator** **3** will flash amber, and the LED under the **AVR Selector** **6** will turn red.
3. Within ten seconds, press the **Surround Mode Selector/Channel Down** button **11**.

4. The red LED under the **AVR Selector** will go out, and the **Program/SPL Indicator** **3** will turn green and flash three times before it goes out.

5. When the **Program/SPL Indicator** **3** goes out, the Macro has been erased.

Programmed Device Functions

Once the AVR 310's remote has been programmed for the codes of other devices, press the appropriate **Input Selector** **5** to change the remote from controlling the AVR 310 to controlling the additional product. When you press any one of the selectors, it will briefly flash in red to indicate that you have changed the device being controlled.

When operating a device other than the AVR 310, the controls may not correspond exactly to the function printed on the remote or button. Some commands, such as the volume control, are the same as they are with the AVR 310. Other buttons will change their function so that they correspond to a secondary label on the remote. For example, the Sleep and Surround mode selector buttons also function as the Channel Up and Channel Down buttons when operating most TV sets, VCRs or cable boxes. The Channel Up/Down indication is printed directly on the remote. For many standard CD players, cassette decks, VCRs and DVD functions, the standard function icons are printed on top of the buttons.

For some products, however, the function of a particular button does not follow the command printed on the remote. In order to see which function a button controls, consult the Function List tables printed on page 40. To use those tables, first check the type of device being controlled (e.g., TV, VCR). Next, look at the remote control diagram pictured at the left. Note that each button has a number on it.

To find out what function a particular button has for a specific device, find the button number on the Function List and then look in the column for the device you are controlling. For example, button number 54 is the Macro 2 button for the AVR 310, but it is the "Favorite" button for many cable television boxes and satellite receivers. Button number 32 is the Delay button for the AVR 310, but the + Time button for CD players.

Programming the Remote

Note that the numbers used to describe the button functions at the left for the purposes of describing how a button operates are a different set of numbers than those used in the rest of this manual to describe the button functions for the AVR 310.

Notes on Using the AVR 310 Remote With Other Devices.

- Manufacturers may use different code sets for the same product category. For that reason, it is important that you check to see if the code set you have entered operates as many controls as possible. If it appears that only a few functions operate, check to see if another code set will work with more buttons.
- When a button is pressed on the AVR 310 remote, the red light under the **Input Selector 5** for the product being operated should flash briefly. If the Device Control Selector flashes for some but not all buttons for a particular product, it does NOT indicate a problem with the remote but rather that no function is programmed for the button being pushed.

Volume Punch-Through

The AVR 310's remote may be programmed to operate the **Volume Control 34** and **Mute 38** functions of either the TV or the AVR 310 in conjunction with any of the devices controlled by the remote. For example, since the AVR 310 will likely be used as the sound system for TV viewing, you may wish to have the AVR 310's volume activated, although the remote is set to run the TV. Either the AVR 310 or TV volume control may be associated with any of the remote's devices. To program the remote for Volume Punch-Through, follow these steps:

- Press the **Input Selector 5** for the unit you wish to have associated with the volume control and the **Mute button 38** at the same time until the red light illuminates under the **Input Selector 5** and note that the **Program/SPL Indicator 3** will flash amber.
- Press the **Volume Up button 34** and note that the **Program/SPL Indicator 3** will stop flashing and stay amber.
- Press either the **AVR Selector 6** or the **Input Selector 5**, depending on which system's volume control you wish to have attached for the punch-through mode. The

Program/SPL Indicator 3 will blink green three times and then go out to confirm the data entry.

Example: To have the AVR's volume control activated even though the remote is set to control the TV, first press the **Video/TV Input Selector 5** and the **Mute button 38** at the same time. Next, press the **Volume Up button 34**, followed by the **AVR Input Selector 6**.

NOTE: Should you wish to return the remote to the original configuration after entering a Volume Punch-Through, you will need to repeat the steps shown above. However, press the same Input Selector in Steps 1 and 3.

Channel Control Punch-Through

The AVR 310's remote may be programmed to operate so that the channel control function for either the TV, cable or satellite receiver used in your system may be used in conjunction with one of the other devices controlled by the remote. For example, while using and controlling the VCR, you may wish to change channels on a cable box or satellite receiver without having to change the device selected by the AVR 310 or the remote. To program the remote for Channel Control Punch-Through, follow these steps:

- Press the **Input Selector button 5** for the device you wish to have the channel control associated with and the **Mute button 38** at the same time until the red light illuminates under the **Input Selector 5** and the **Program/SPL Indicator 3** flashes amber.
- Press the **Volume Down button 34**. The **Program/SPL Indicator 3** will stop flashing and stay amber.
- Press and release the **Input Selector button 5** for the device that will be used to change the channels. The **Program/SPL Indicator 3** will blink green three times and then go out to confirm the data entry.

Example: To control the channels using your Cable Box or Satellite Receiver while the remote is set to control the VCR, first press the **VID 1/VCR Input Selector button 5** and the **Mute button 38** at the same time. Next, release them and press the **Volume Down button 34**, followed by the **VID 2/TV Input Selector button 5**.

NOTE: To remove the Channel Control Punch-Through and return the remote to its original configuration, repeat the steps shown in the example above. However, press the **VID 1/VCR Input Selector** in Steps 1 and 3.

Transport Control Punch-Through

The AVR 310's remote may be programmed to operate so that the Transport Control Functions **24** (Play, Stop, Fast Forward, Rewind, Pause and Record) for a VCR, DVD or CD will operate in conjunction with one of the other devices controlled by the remote. For example, while using and controlling the TV, you may wish to start or stop your VCR or DVD without having to change the device selected by the AVR 310 or the remote. To program the remote for Transport Control Punch-Through, follow these steps:

- Press the **Input Selector 5** for the device you wish to have the channel control associated with and the **Mute button 38** at the same time until the red light illuminates, under the **Input Selector 5** and the **Program/SPL Indicator 3** flashes amber.
- Press the **Play button 24**. The **Program/SPL Indicator 3** will stop flashing and stay amber.
- Press and release the **Input Selector button 5** for the device that will be used to change the channels. The **Program/SPL Indicator 3** will blink green three times and then go out to confirm the data entry.

Example: To control the transport of a DVD player while the remote is set to control the TV, first press the **VID 2/TV Input Selector button 5** and the **Mute button 38** at the same time. Next, release them and press the **Play button 24**, followed by the **DVD Input Selector button 5**.

NOTE: To remove the Channel Control Punch-Through and return the remote to its original configuration, repeat the steps shown in the example above. However, press the **VID 2/TV Input Selector** in Steps 1 and 3.

NOTE: Before programming the remote for Volume, Channel or Transport Punch-Through, make certain that any programming needed for the specific TV, CD, DVD, Cable or Satellite Receivers has been completed.

Programming the Remote

Reassigning Device Control Selectors

Although each **Input Selector 5** is normally assigned to the category of product shown on the remote, it is possible to reassign one of these buttons to operate a second device of another type. For example, if you have two VCRs but no satellite receiver, you may program the "SAT" button to operate a second VCR. Before following the normal programming steps for either Three-Digit entry or Auto Search code entry, you must first reassign the button with the following steps:

1. Press the **Input Selector 5** you wish to reassign and the **Mute button 38** at the same time until the red light illuminates under the **Input Selector 5** and the **Program/SPL Indicator 3** flashes amber.
2. Press the **Input Selector 5** for the device you wish to program into the reassigned button.
3. Enter the three-digit code for the specific model you wish the reassigned button to operate.
4. Press the same **Input Selector 5** pressed in Step 1 once again to store the selection. The red LED under the re-assigned Input Selector will flash three times and then go out.

Example: To use the CBL/SAT button to operate a second VCR, first press the **CBL/SAT Input Selector 5** and the **Mute button 38** at the same time until the red light glows under the **CBL/SAT 5** button. Press the **VCR 5** button, followed by the three-digit code for the specific model you wish to control. Finally, press the **CBL/SAT 5** button again.

Resetting the Remote Memory

As you add components to your home-theater system, occasionally you may wish to totally reprogram the remote control without the confusion of any commands, macros or "Punch-Through" programming that you may have done. To do this, it is possible to reset the remote to the original factory defaults and command codes by following these steps. Note, however, that once the remote is reset, all commands or codes that you have entered will be erased and will need to be re-entered:

1. Press any of the **Input Selector buttons 5** and the **"0" button 18** at the same time until the **Program/SPL Indicator 3** begins to flash amber.
2. Press the **"3" button 18** three times.
3. The red LED under the **Input Selector 5** will go out and the **Program/SPL Indicator 3** will stop flashing and turn green.
4. The **Program/SPL Indicator 3** will remain green until the remote is reset. Note that this may take a while, depending on how many commands are in the memory and need to be erased.
5. When the **Program/SPL Indicator 3** goes out, the remote has been reset to the factory settings.

Function List

No.	Button Name	AVR Function	DVD	CD/CDR	Tape	VCR (VID 1)	TV (VID 1)	CBL (VID 3)	SAT(VID 3)
1	Power Off	Power Off	Power Off	Power Off	Power Off	Power Off	Power Off	Power Off	Power Off
2	Power On	Power On	Power On	Power On	Power On	Power On	Power On	Power On	Power On
3	Mute	Mute	Mute	Mute	Mute	Mute	Mute	Mute	Mute
4	AVR	AVR Select							
5	DVD	DVD Input Select	DVD Select						
6	CD	CD Input Select		CD Select					
7	Tape	Tape Input Select			Tape Select				
8	VID 1	Video 1 Select				VCR Select	TV Select	VID 3 Select	
9	VID 2	Video 2 Select							
10	VID 3	Video 3 Select							
11	VID 4	Video 4 Select							
12	Learn								
13	AM/FM	Tuner Select							
14	6 Ch. Select	6 Ch Input Select							
15	SPL				Left	Left	Left	Left	Left
16	Sleep	Sleep					Channel +	Channel +	Channel +
17	Test	Test Tone		Input Select					
18	TV		TV/DVD	CDP Select		TV/VCR	TV/VCR	TV/Cable	TV/Sat
19	Volume Up	Volume Up		Input Level Up		Volume Up	Volume Up	Volume Up	Volume Up
20	Surround Select	Surround Mode Select		CDR Select		Channel –		Channel –	Channel –
21	Night	Night Mode Select							
22	Multi Room	Multi-Room Select							
23	Volume Down	Volume Down		Input Level Down			Volume Down	Volume Down	Volume Down
24	Channel/Guide	Channel Trim	Title					Info/Guide	Info/Guide
25	▲	Move/Adjust Up	Up			Up	Up	Up	Up
26	Speaker/Menu	Speaker Adjust	Menu			Menu	Menu	Menu	Menu
27	◀	Move/Adjust Left	Left			Left	Left	Left	Left
28	Set	Set	Enter			Enter	Enter	Enter	Enter
29	▶		Right			Right	Right	Right	Right
30	Digital/Exit	Digital Input Select	Subtitle			Exit	Exit	Exit	Exit
31	▼	Move/Adjust Down	Down			Down	Down	Down	Down
32	Delay/Prev. Ch.	Delay Adjust	Return	Time			Prev Channel	Prev Channel	Prev Channel
33	1		1	1		1	1	1	1
34	2		2	2		2	2	2	2
35	3 ◀◀		3	3		3	3	3	3
36	4 ▶▶ 		4	4		4	4	4	4
37	5		5	5		5	5	5	5
38	6		6	6		6	6	6	6
39	7		7	7		7	7	7	7
40	8		8	8		8	8	8	8
41	Tun-M	Tuner Mode							
42	9		9	9		9	9	9	9
43	0		0	0		0	0	0	0
44	Memory								

Function List

No.	Button Name	AVR Function	DVD	CD/CD-R	Tape	VCR (VID 1)	TV (VID 1)	CBL (VID 3)	SAT (VID 3)
45	Tune Up	Tune Up	Next Chapter						
46	Direct	Direct Tuner Entry		Track Direct					
47	Clear	Clear	Clear	Clear		Clear	Clear	Clear	Clear
48	Preset Up	Preset Tune Up	Slow Forward						
49	Tune Down	Tune Down	Prev Chapter	Track Increment					
50	OSD	OSD				OSD	OSD	OSD	OSD
51	D. Skip		Disc Skip	Disc Skip	Stop	Stop			
52	Preset Down	Preset Tune Down	Slow Rev	Intro Scan					
53	M1		Open/Close	Open/Close		Cancel	Sleep	PPV	Cancel
54	M2		Subtitle On/Off	Repeat				Fav	Fav
55	M3		Audio Select	Random Play				Bypass	Next
56	M4		Angle Select					Music	Alt
57	Rewind		R. Search	R. Search	Rewind	Rewind		Day -	Say -
58	Play		Play	Play	Play	Play			
59	Fast Forward		F. Search	F. Search	Fast Fwd	Fast Fwd		Day +	Day +
60	Record			Record	Record	Record			
61	Stop		Stop	Stop	Stop	Stop			
62	Pause		Pause	Pause	Pause	Pause			
63	Skip Down		Skip -	Skip -		Scan -		Page -	Page -
64	Skip Up		Skip +	Skip +		Scan +		Page +	Page +

Setup Code Table: TV

Manufacturer/Brand	Setup Code Number
A MARK	103 132
ADMIRAL	192
AKAI	001 160
AMPRO	070 164
AMSTRAD	053
ANAM	045 055 057 076 095 099 103 106 109 112 122
AOC	001 011 103
BLAUPUNKT	084
BROKSONIC	205 206
CANDLE	001 002 003 011
CAPEHART	059
CENTURION	170 171
CENTRONIC	045
CITIZEN	001 002 003 011 045 092 094 132
CLASSIC	045
CONCERTO	011
CONTEC	041 045 051 052
CORANDO	172
CORONADO	132
CRAIG	045 055 157 158 159
CROWN	045 132
CURTIS MATHES	001 092 107 132
CXC	045
DAEWOO	011 022 023 038 045 046 056 068 073 094 098 102 105 108 111 114 116 118 119 127 132
DAYTRON	107 132
DIGI LINK	200
DYNASTY	045
DYNATECH	063
ELECTROHOME	074 132
EMERSON	001 012 033 045 048 049 051 052 091 107 132 137 139 141 157 158 162 205
FISHER	013 058
FUNAI	033 045
FUTURETECH	045
GE	001 014 015 038 057 070 071 107 121 133 141 145 163 199
GOLDSTAR	011 093 097 101 103 104 107 110 113 118 128 132
GRUNDIG	193
HALL MARK	107
HARMAN KARDON	201
HITACHI	001 011 015 016 017 018 029 043 072 132 144 147
INFINITY	148
INKEL	120
JBL	148
JC PENNEY	001 011 014 015 030 035 092 132 145
JENSEN	019
JVC	038 040 079 134
KAWASHO	173
KEC	045
KENWOOD	001 204
KLOSS	002 060
KMC	132
KTV	001 045 132 162
LLOYTRON	172 173
LODGENET	069
LOGIK	069
LUXMAN	011
LXI	013 021 053 077 145 148
MAGNAVOX	001 003 011 060 061 062 064 065 118 132 145 148
MARANTZ	001 074 148
MATSUI	148
MEMOREX	013 069 107
METZ	084
MGA	001 011 033 044 050 074 107

Setup Code Table: TV (continued)

MIDLAND	199
MINERVA	084
MITSUBISHI	001 011 030 033 042 044 100 107 115 154 160 167 168
MTC	175 176
NAD	021 031
NATIONAL	177 178 179 180 181 182
NEC	001 013 022 025 030 042 057 121 123 125
NIKEI	045
ONKING	045
ONWA	045
OPTONICA	025 077
ORION	207 208 209 210 211
PANASONIC	038 057 076 087 148 169
PENNEY	199
PHILCO	001 003 011 030 045 057 060 061 064 065 118 132 148
PHILIPS	001 003 011 040 060 067 088 132 145 148
PIONEER	001 024 029 031 032 107 213 214
PORTLAND	011 132
PROSCAN	133
PROTON	059 107 122 132 165
QUASAR	038 057 087
RADIO SHACK	025 045 048 107 118 132 195 196 197 198
RCA	001 011 029 030 057 071 133 145 161 163 199
REALISTIC	013 025 045 048 195 196 197
RUNCO	152 153
SAA	183
SAMPO	001 059 107
SAMSUNG	051 085 092 096 104 107 118 124 128 132 145
SANYO	013 026 027 037 041 054 058 078
SCOTT	033 045 049 107 132
SEARS	011 013 021 033 035 058 078 092 107 132 145
SHARP	011 020 025 028 033 034 077 132 154
SIEMENS	084
SIGNATURE	069
SONY	043 067 075 117 130 136 194 212
SOUNDESIGN	003 033 045 107
SPECTRICON	103
SSS	011 045
SUPREMACY	002
SYLVANIA	001 003 011 060 061 064 065 107 118 131 145 148
SYMPHONIC	184
TANDY	077
TATUNG	057 063
TECHNICS	080
TECHWOOD	011
TEKNIKA	001 002 003 011 030 033 036 045 069 074 092 094 132
TELEFUNKEN	039 047 083
TELERENT	069
TERA	156
THOMSON	190 191
TMK	011 107
TOSHIBA	013 021 035 042 052 063 092 129 202
TOTEVISION	132
UNIVERSAL	014 015
VIDEO CONCEPTS	160
VIDTECH	011 107
WARDS	011 014 015 025 033 061 062 064 065 069 071 107 132 148
YAMAHA	001 011
YORK	107
YUPITERU	045
ZENITH	069 070 090 094
ZONDA	103

Setup Code Table: VCR

Manufacturer/Brand	Setup Code Number
AIWA	040
AKAI	022 048 050 108 109 126
AMPRO	076
AMSTRAD	133
ANAM	037 039 089
ASA	134
AUDIO DYNAMICS	018 029 044 048
BROKSONIC	041 043 110 147 166
CANDLE	134 135 137
CANON	034 037 039 135 140
CAPEHART	094
CITIZEN	134
CRAIG	003 045 116
CURTIS MATHES	037 039
DAEWOO	012 014 017 068 069 094 096 097 098 102 103 104
DAYTRON	094
DBX	018 029 044 048
DUAL	136
DYNATECH	040 057
ELECTROHOME	063
EMERSON	013 023 031 033 035 037 040 041 042 043 050 087 110 112 119
FERGUSON	136
FINLUX	133
FISHER	003 015 016 017
FUNAI	040 133
GE	037 039 067 076 093 095 124 127
GO VIDEO	113 117
GOLDSTAR	018 019 026 087 092 100 107
GRAETZ	136
HARMAN KARDON	018 049
HITACHI	011 040 048 067 118 130
INSTANT REPLAY	037 039
ITT	136
JCL	037 039
JC PENNEY	018 019 021 039 045 070 087
JENSEN	048
JVC	018 037 039 048 052 054 059 064 111 130 132
KENWOOD	020 044 048 052
LLOYD	040
LXI	019 020 040 087
MAGIN	045
MAGNAVOX	037 039 040 071 072
MARANTZ	018 037 039 071 073
MARTA	087
MATSUI	033 036
MEI	037 039
MEMOREX	003 017 020 037 039 040 057 076 087 115 120
MGA	049 050 063
MINOLTA	019 026
MITSUBISHI	019 026 049 050 053 055 063 065 131 145 146
MTC	133
MULTITECH	030 040
NAD	139
NATIONAL	140
NEC	018 029 044 048 052

Setup Code Table: VCR (continued)

NORDMENDE	048
OPTIMUS	159
OPTONICA	057 058
ORION	147 166
PANASONIC	070 074 078 086 114 125 150 167 172
PENTAX	019 026 037 039 067
PHILCO	037 039 040 071
PHILIPS	037 039 040 058 071 075 087
PILOT	087
PIONEER	019 027 052
PORTLAND	094
PULSAR	076
QUARTZ	001 020
QUASAR	039 070 079 125 144
RADIO SHACK	133 134 137 140 141 142 152 158 159 160 161
RCA	019 026 039 066 067 093 095 124 125 127 157 172
REALISTIC	003 015 017 020 037 039 040 045 057 058 087 137 152 159 160
RICO	062
RUNCO	128
SABA	136
SAISHO	143
SALORA	020
SAMSUNG	038 045 088 090 091 093 095 098 099 101 105 106 109
SANSUI	028 048 052 116 147 166
SANYO	003 014 017 020 115
SCHAUB LORENZ	136
SCOTT	023 043 098 110 112
SEARS	003 015 016 017 019 020 026 037 047 077 084 087
SHARP	037 058 129 156
SHINTOM	030
SONY	003 016 037 056 060 061 062 080 081 082 129
SOUNDESIGN	040
STS	019
SYLVANIA	037 039 040 063 071
SYMPHONIC	040
TANDY	017 040
TASHICO	134
TATUNG	044 048
TEAC	040 044 048
TECHNICS	037 039
TEKNIKA	025 037 039 040 087
TELEFUNKEN	136
THOMAS	040
THOMSON	136
THORN	136
TMK	013
TOSHIBA	015 019 047 051 063 085 098 112 155
TOTEVISION	045 087
UNITECH	045
VECTOR RESEARCH	018
VICTOR	052
VIDEO CONCEPTS	018 040 050
VIDEOSONIC	045
WARDS	003 019 023 030 037 039 040 045 057 058 112
YAMAHA	018 040 044 048
ZENITH	040 052 060 062 076 083 087

Setup Code Table: CD

Manufacturer/Brand	Setup Code Number
ADC	012
ADCOM	049 063 069
AIWA	072 111 118 156 170
AKAI	050 177 184
AUDIO TECHNICA	053
AUDIOACCESS	125
AUDIOFILE	211
BSR	044 064
CALIFORNIA AUDIO	015 109
CAPETRONIC	070
CARRERA	064 087
CARVER	051 057 136 140 141 143 144 145 185 186
CASIO	066 117 122 166
CLARINETTE	122 166
CROWN	042
CURTIS MATHES	066
DENON	187 188 213
EMERSON	049 052 093 108
FISHER	023 055 057 068
FRABA	117
FUNAI	126
GE	164
GENEXXA	017 096 108
GOLDSTAR	016 087
HAITAI	099 214
HARMAN KARDON	001 002 025 040 054 190 218 219
HITACHI	049 093
INKEL	026 027 216
JC PENNEY	021 066 098 147
JENSEN	153
JVC	029 176 195 196
KENWOOD	014 020 023 030 062 078 079 148 151 176 178 181
KYOCERA	012
LOTTE	108
LUXMAN	018 035 077 102
LXI	066 164
MAGNAVOX	039 051 113
MARANTZ	043 051 058 084 191 192 193
MCINTOSH	194
MCS	021 066 080 098
MEMOREX	096
MGA	032
MISSION	051
MINIBOX	032
MITSUBISHI	032
MITSUMI	152
MODULAIRE	122 166
NAD	013 074 197 198
NAKAMICHI	199 200 201
NEC	021 069
NIKKO	053 055
NSM	051

Setup Code Table: CD (continued)

ONKYO	037	038	045	046	171	175	202	203							
OPTIMUS	020	036	056	057	064	065	089	090	091	092	096	099	104	212	
PANASONIC	015	075	109	119	158	183	204								
PHILIPS	039	051	138	149	209										
PIONEER	017	036	071	094	096	100	112	123	131	160	161	162	215		
PROTON	051	210													
QUASAR	015	109													
RADIO SHACK	122	126	213												
RCA	024	049	081	093	150										
RCX	169														
REALISTIC	049	056	057	058	093	095	104	105	108	164	166				
ROTEL	051														
SAE	051														
SAMSUNG	028														
SANSUI	047	051	081	134	157	172									
SANYO	033	057	068	082	095	168									
SCOTT	108														
SEARS	066														
SHARP	020	058	073	105	114	151	159	167	180	181					
SHERWOOD	003	026	027	041	058	105	133								
SIGNATURE	040														
SONY	060	103	115	116	118	132	139	163	205	206	207	208	212	217	
SOUNDSTREAM	124														
STS	012														
SYLVANIA	051														
SYMPHONIC	059	110													
TAEKWANG	177														
TANDY	096														
TEAC	011	022	048	058	085	086	106	107	110	121	137	146	154		
TECHWOOD	083														
THETA DIGITAL	039														
TOSHIBA	013	074	097	151	155	173									
VECTOR RESEARCH	087														
VICTOR	029	120	130												
WARDS	040	095													
YAMAHA	019	031	053	061	135	169									
YORK	122	166													

Setup Code Table: Tape

Manufacturer/Brand	Setup Code Number
HARMAN KARDON	001

Setup Code Table: Audio

Manufacturer/Brand	Setup Code Number
HARMAN KARDON	001

Setup Code Table: DVD

Manufacturer/Brand	Setup Code Number
APEX DIGITAL	061
CALIFORNIA AUDIO	040
DENON	002 019 022 034 051
GE	003 004
GOLDSTAR	005
HARMAN KARDON	001 032
JVC	006
KENWOOD	007 050
LG	005 055 064
LOTTE	008
MAGNAVOX	033 056
MARANTZ	033 059
MITSUBISHI	023 036
NAD	010 062
ONKYO	009 015 048
OPTIMUS	011 050
PANASONIC	024 025 030 034 035 044 052
PHILIPS	033 056
PIONEER	012 020 038 041 046 047 065
PROCEED	060
PROSCAN	003 004 037
RCA	003 004 018 037
RUNCO	027
SAMSUNG	031 053 054
SANYO	013 049
SHARP	021 028 050
SONY	015 029 043 045
TECHNICS	026
THOMSON	003 004
TOSHIBA	009 033 047 057 058
YAMAHA	016 017 030 063
ZENITH	005 033 055 064
ZENITH DIVX	039

Setup Code Table: SAT

Manufacturer/Brand	Setup Code Number															
ALPHASTAR	472															
ALPHASTAR DBS	450															
ALPHASTAR DSR	422	442														
AMPLICA	356															
BIRDVIEW	414	425														
BSR	359															
CAPETRONICS	359															
CHANNEL MASTER	320	321	322	325	361											
CHAPARRAL	315	316	319	380	451											
CITOH	360															
CURTIS MATHES	356															
DRAKE	312	313	317	318	413	481										
DX ANTENNA	331	352	362	379	483											
EHOSTAR	364	395	397	452	453	463	477	478	484	485						
ELECTRO HOME	392															
EUROPLUS	415															
FUJITSU	324	328	329	334												
GENERAL INSTRUMENT	303	311	323	365	403	454	468	474								
HITACHI DBS	455															
HOUSTON TRACKER	463															
HUGHES	372	437														
HYTEK	359															
JANIEL	366															
JERROLD	367	454	464	468												
KATHREIN	410															
LEGEND	453															
LUXOR	368															
MACOM	317	365	369	370	371											
MAGNAVOX	461	473														
MEMOREX	453															
NEXTWAVE	423	424														
NORSAT	373	374														
OPTIMUS	466															
PANASONIC	366	469														
PANASONIC DBS	457															
PANSAT	420															
PERSONAL CABLE	418															
PHILIPS	375															
PICO	407															
PRESIDENT	326	404														
PRIMESTAR	412	454	464	475												
RCA	301	408	436	439	458	465										
REALISTIC	349	377	480													
SAMSUNG	422	442														
SATELLITE SERVICE CO	335	341	353	388												
SCIENTIFIC ATLANTA	339															
SONY	405	438														
STAR CHOICE DBS	459															
STARCAST	347															
SUPER GUIDE	327	423	424													
TEECOM	330	333	378	390	391	393	409									
TOSHIBA	302	426	443	460	461	462	470									
UNIDEN	323	332	348	349	350	351	354	355	381	382	383	389	403	466	479	480
ZENITH	385	386	387	394	419											

Setup Code Table: CBL

Manufacturer/Brand	Setup Code Number
ABC	001 003 011 045 048 052 059 110
ALLEGRO	111
AMERICAST	212
ANTRONIX	021
ARCHER	012 014 021 031 112
BELCOR	113
CABLE STAR	033 113
CENTURION	092
CENTURY	014
CITIZEN	014 111
COLOUR VOICE	069 090
COMBANO	083 084
COMTRONICS	026 037
DIAMOND	030
DIGI	114
EAGLE	027 037 046 186
EASTERN	063 066 070 115
ELECTRICORD	039
EMERSON	112
FOCUS	116
G.I.	001 003 011 015 017 093 095 096 097
GC ELECTRONICS	113
GE	076
GEMINI	015 029 032 060
GENERAL	210
GENERAL INSTRUMENT	168
GOLDEN CHANNEL	037
GOODMIND	112
HAMLIN	055 056 061 099 100 101 117 175 207 208
HITACHI	001 061 188
HOSPITALITY	074 080
JASCO	111
JERROLD	001 002 003 011 015 016 017 073 093 095 096 097 162 167
LINDSAY	118
M-NET	043
MACOM	040 191
MAGNAVOX	017 019 068 082
MEMOREX	058
MOVIE TIME	035 039
NSC	022 035 044 075 190
OAK	023 038 043 059 094 196 197
PACE	179
PANASONIC	050 053 176 177 189 214
PANTHER	114
PARAGON	058
PHILIPS	013 019 020 027 069 085 090
PIONEER	001 041 057 079 119 171 200 209
POPULAR MECHANICS	116
POST NEWS WEEK	023
PRELUDE	120
PRIMESTAR	162
PTS	018 054 075 076

Setup Code Table: CBL (continued)

PULSAR	058
RADIO SHACK	111 112 213
RCA	053 214
RECOTON	116
REGAL	055 056 061 099 100 101 207
REGENCY	063 115
REMBRANT	032
SAMSUNG	037 072 186
SCIENTIFIC ATLANTA	003 018 047 048 049 051 052 110 183 184 203 204
SEAM	121
SHERITECH	029
SIGNAL	037
SIGNATURE	001 188
SL MARX	037
SPRUCER	053 081 177 189
STARCOM	002 011 015 016 163
STARGATE	015 037 120
SYLVANIA	071
TADIRAN	037
TANDY	024
TELECAPATION	028
TEXSCAN	036 071
TFC	122
TIMELESS	123
TOCOM	045 046 062 170 205
TOSHIBA	058
UNIKA	014 021 031
UNITED CABLE	011 059
UNIVERSAL	012 014 021 031 033 034 039 042 113
VIDEOWAY	124 211
VIEWSTAR	019 022 025 086 087 088 089 190
ZENITH	058 065 098 125 211
ZENITEK	116

Troubleshooting Guide

SYMPTOM	CAUSE	SOLUTION
Unit does not function when Main Power Switch is pushed	<ul style="list-style-type: none"> No AC Power 	<ul style="list-style-type: none"> Make certain AC power cord is plugged into a live outlet Check to see if outlet is switch-controlled
Display lights, but no sound or picture	<ul style="list-style-type: none"> Intermittent input connections Mute is on Volume control is down 	<ul style="list-style-type: none"> Make certain that all input and speaker connections are secure Press Mute button Turn up volume control
Unit turns on, but Front-Panel Display does not light up	<ul style="list-style-type: none"> Display brightness is turned off 	<ul style="list-style-type: none"> Follow the instructions in the Display Brightness section on page 32 so that the display is set to VFD FULL
No sound from any speaker; light around power switch is red	<ul style="list-style-type: none"> Amplifier is in protection mode due to possible short Amplifier is in protection mode due to internal problems 	<ul style="list-style-type: none"> Check speaker wire connections for shorts at receiver and speaker ends Contact your local Harman Kardon service depot
No sound from surround or center speakers	<ul style="list-style-type: none"> Incorrect surround mode Input is monaural Incorrect configuration Stereo or Mono program material 	<ul style="list-style-type: none"> Select a mode other than Stereo There is no surround information from mono sources Check speaker mode configuration The surround decoder may not create center or rear channel information from nonencoded programs
Unit does not respond to remote commands	<ul style="list-style-type: none"> Weak batteries in remote Wrong device selected Remote sensor is obscured 	<ul style="list-style-type: none"> Change remote batteries Press the AVR selector Make certain front panel sensor is visible to remote or connect remote sensor
Intermittent buzzing in tuner	<ul style="list-style-type: none"> Local interference 	<ul style="list-style-type: none"> Move unit or antenna away from computers, fluorescent lights, motors or other electrical appliances
Letters flash in the Channel Indicator Display and Digital Audio stops	<ul style="list-style-type: none"> Digital audio feed paused 	<ul style="list-style-type: none"> Resume play for DVD Check that Digital Input is selected

Processor Reset

In the rare case where the unit's operation or the displays seem abnormal, the cause may involve the erratic operation of the system's memory or microprocessor.

To correct this problem, first unplug the unit from the AC wall outlet and wait at least three minutes. After the pause, reconnect the AC power cord and check the unit's operation. If the system still malfunctions, a system reset may clear the problem.

To clear the AVR 310's entire system memory including tuner presets, output level settings,

delay times and speaker configuration data, first put the unit in Standby by pressing the **System Power Control** button **2**. Next, press and hold the **Tone Mode** **6** and the **FM Mode Selector** **12** buttons for three seconds.

The unit will turn on automatically and display the **RESET** message in the **Main Information Display** **Y**. Note that once you have cleared the memory in this manner, it is necessary to re-establish all system configuration settings and tuner presets.

NOTE: Resetting the processor will erase any configuration settings you have made for

speakers, output levels, surround modes, digital input assignments as well as the tuner presets. After a reset the unit will be returned to the factory presets, and all settings for these items must be reentered.

If the system is still operating incorrectly, there may have been an electronic discharge or severe AC line interference that has corrupted the memory or microprocessor.

If these steps do not solve the problem, consult an authorized Harman Kardon service depot.

Technical Specifications

Audio Section

Stereo Mode

Continuous Average Power (FTC)

60 Watts per channel, 20Hz–20kHz,
@ < 0.07% THD, both channels driven into 8 ohms

Five-Channel Surround Modes

Power Per Individual Channel

Front L&R channels:
50 Watts per channel
@ < 0.07% THD, 20Hz–20kHz into 8 ohms

Center channel:
50 Watts @ < 0.07% THD, 20Hz–20kHz into 8 ohms

Surround channels:
50 Watts per channel
@ < 0.07% THD, 20Hz–20kHz into 8 ohms

Input Sensitivity/Impedance

Linear (High-Level) 200mV/47k ohms

Signal-to-Noise Ratio (IHF-A) 95dB

Surround System Adjacent Channel Separation

Analog Decoding 40dB
(Pro Logic, etc.)

Dolby Digital (AC-3) 55dB
DTS 55dB

Frequency Response

@ 1W (+0dB, –3dB) 10Hz–100kHz

High Instantaneous

Current Capability (HCC) ±35 Amps

Transient Intermodulation

Distortion (TIM) Unmeasurable

Rise Time 16 µsec

Slew Rate 40V/µsec

FM Tuner Section

Frequency Range	87.5–108MHz
Usable Sensitivity	IHF 1.3 µV/13.2dB
Signal-to-Noise Ratio	Mono/Stereo 70/68dB
Distortion	Mono/Stereo 0.2/0.3%
Stereo Separation	40dB @ 1kHz
Selectivity	±400kHz, 70dB
Image Rejection	80dB
IF Rejection	90dB
Tuner Output Level	1kHz, ±75kHz Dev 500mV

AM Tuner Section

Frequency Range	520–1710kHz
Signal-to-Noise Ratio	45dB
Usable Sensitivity	Loop 500µV
Distortion	1kHz, 50% Mod 0.8%
Selectivity	±10kHz, 30dB

Video Section

Television Format	NTSC
Input Level/Impedance	1Vp-p/75 ohms
Output Level/Impedance	1Vp-p/75 ohms
Video Frequency Response	10Hz–8MHz (–3dB)

General

Power Requirement	AC 120V/60Hz
Power Consumption	72W idle, 580W maximum (2 channels driven)

Dimensions (Max)

Width	17.3 inches (440mm)
Height	6.5 inches (165mm)
Depth	17.1 inches (435mm)

Weight 32 lb (14.5 kg)

Depth measurement includes knobs, buttons and terminal connections.

Height measurement includes feet and chassis.

All features and specifications are subject to change without notice.

Harman Kardon is a registered trademark, and Power for the Digital Revolution is a trademark, of Harman International Industries, Inc.

|||||EzSet™ is a trademark of Harman International Industries, Inc. (Patent No. 5,386,478).

*Manufactured under license from Dolby Laboratories.

“Dolby,” “Pro Logic,” “AC-3” and the Double-D symbol are trademarks of Dolby Laboratories. Confidential Unpublished Works. ©1992–1999 Dolby Laboratories, Inc. All rights reserved.

DTS and DTS Surround are trademarks of Digital Theater Systems, Inc.

VMAx is a registered trademark of Harman International Industries, Inc., and is an implementation of Cooper Bauck Transaural Stereo under patent license.

Logic 7 is a registered trademark of Lexicon, Inc.

Crystal is a registered trademark of Cirrus Logic Corp.

Notes

harman/kardon

H A Harman International Company
250 Crossways Park Drive, Woodbury, New York 11797
www.harmankardon.com
© 2000 Harman Kardon, Incorporated
Part No.: J90200012200